

ПОИСКИ РАЗУМА В МОЗГЕ: ЧТО ТАКОЕ ПАМЯТЬ И СОЗНАНИЕ

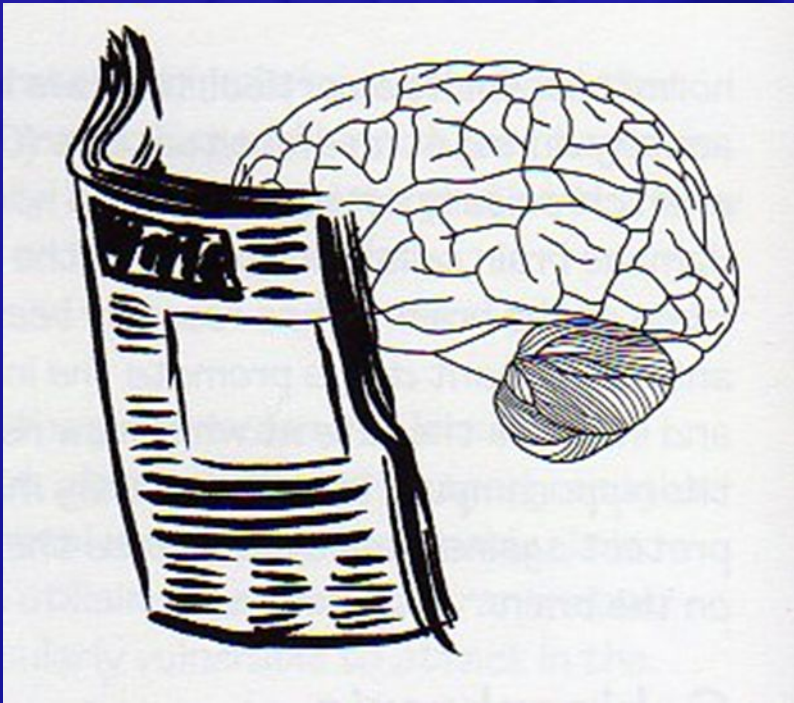

Сварник ОЕ

(Институт психологии РАН,
Москва)

Основное

- ✓ Что мы увидели, когда получили возможность «заглянуть внутрь мозга»?
- ✓ Как «внутри мозга» добавляются знания?
- ✓ Какая связь между знанием и сознанием?

КАК «РАБОТАЕТ» НАШ МОЗГ?



КАК НЕ «РАБОТАЕТ» НАШ МОЗГ

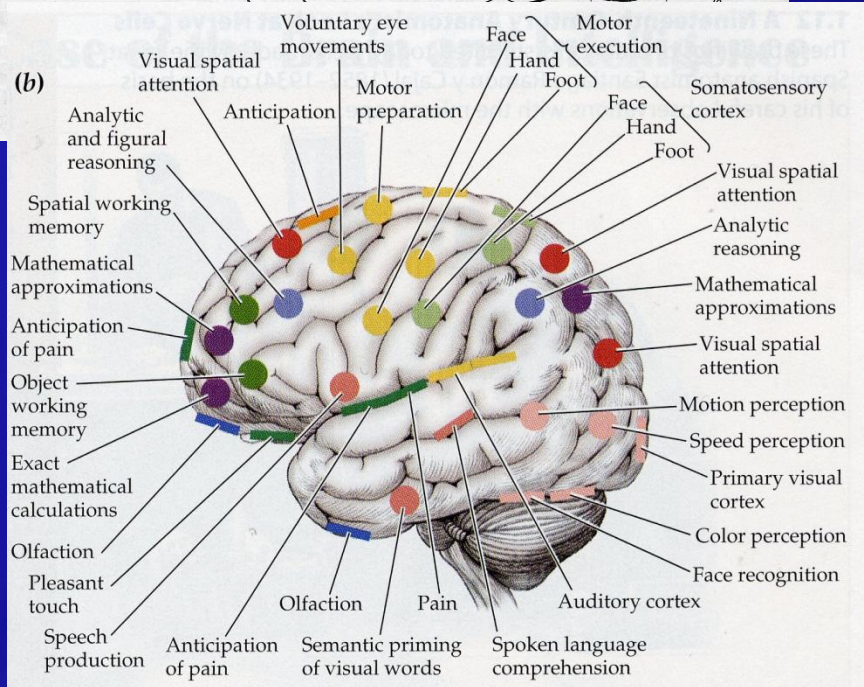
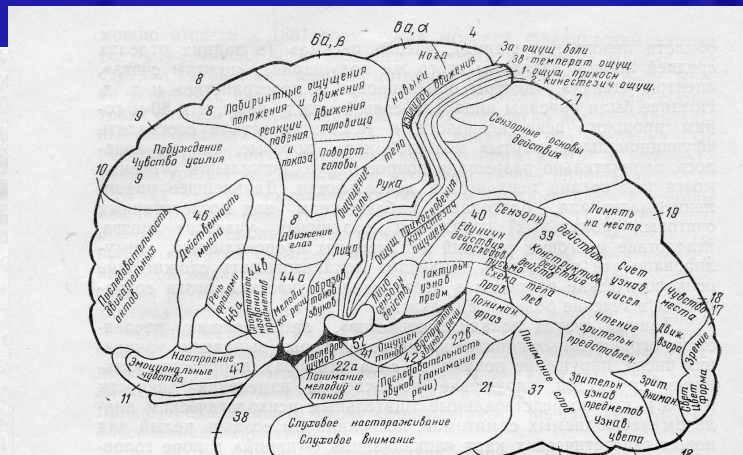
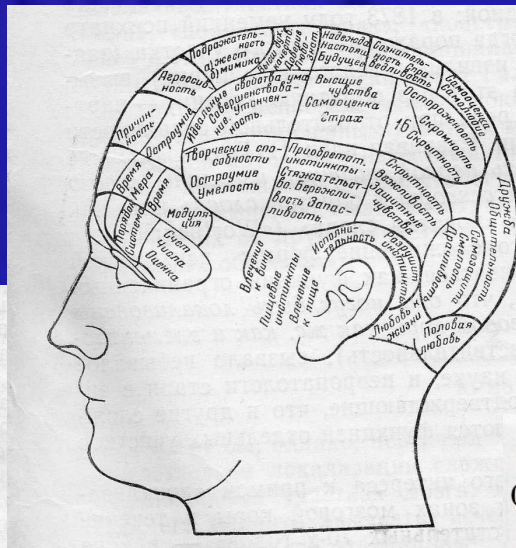
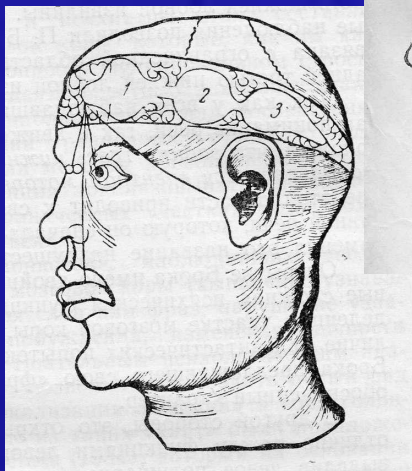

Любая структура мозга
СОСТОИТ
ИЗ ОТДЕЛЬНЫХ КЛЕТОК

Motor cortex

Sensory cortex

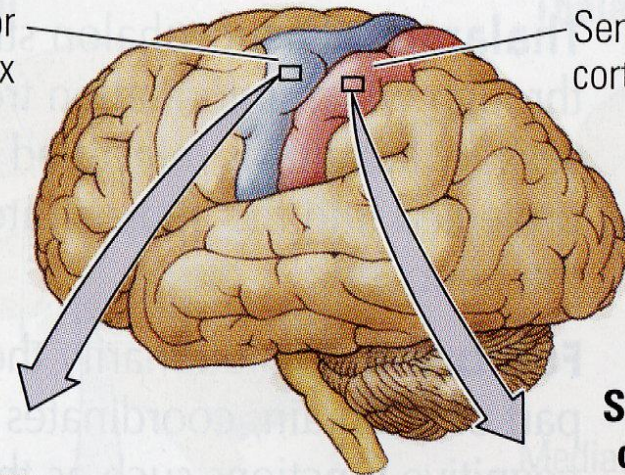

Motor cortex

Sensory cortex

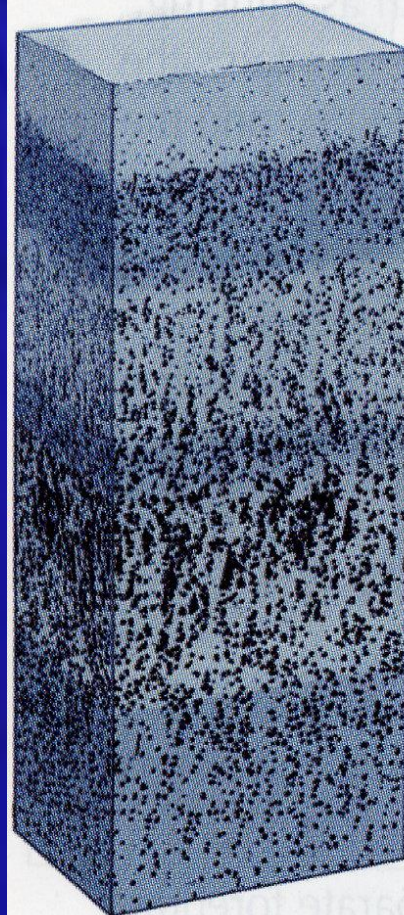

I }
II } Integrative functions
III }
IV }
V } Input of sensory information
VI }
Output to other parts of brain

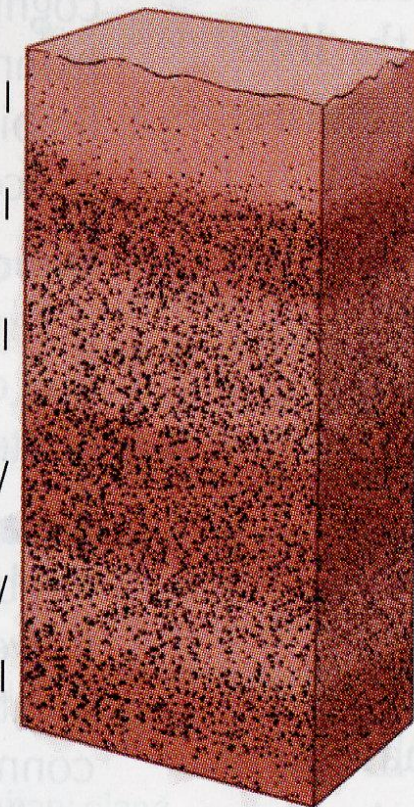

I }
II }
III }
IV }
V }
VI }

make
bert
the s
sory
Mot
disti

also com

«РАБОТА» МОЗГА СКЛАДЫВАЕТСЯ ИЗ АКТИВАЦИЙ ОТДЕЛЬНЫХ НЕЙРОНОВ

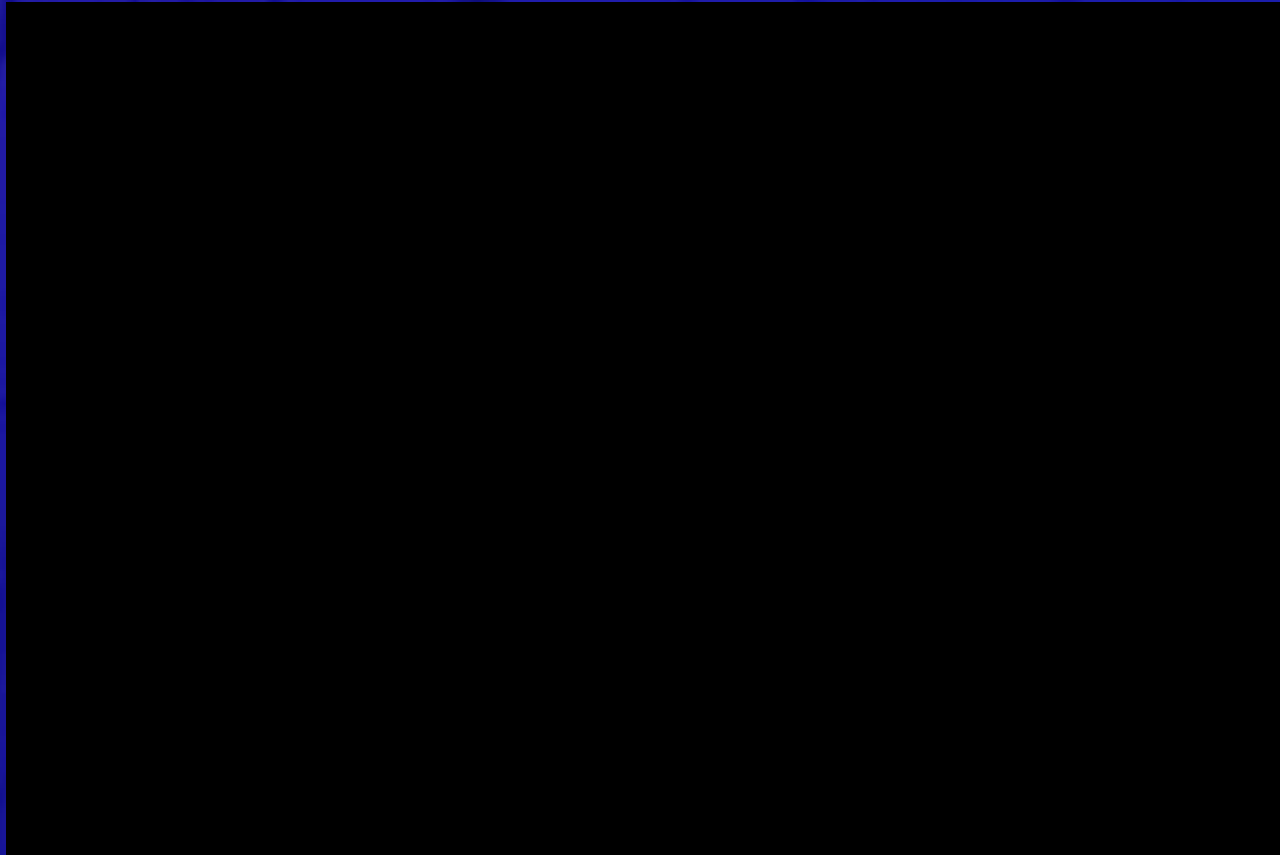

«РАБОТА» МОЗГА СКЛАДЫВАЕТСЯ ИЗ АКТИВАЦИЙ ОТДЕЛЬНЫХ НЕЙРОНОВ

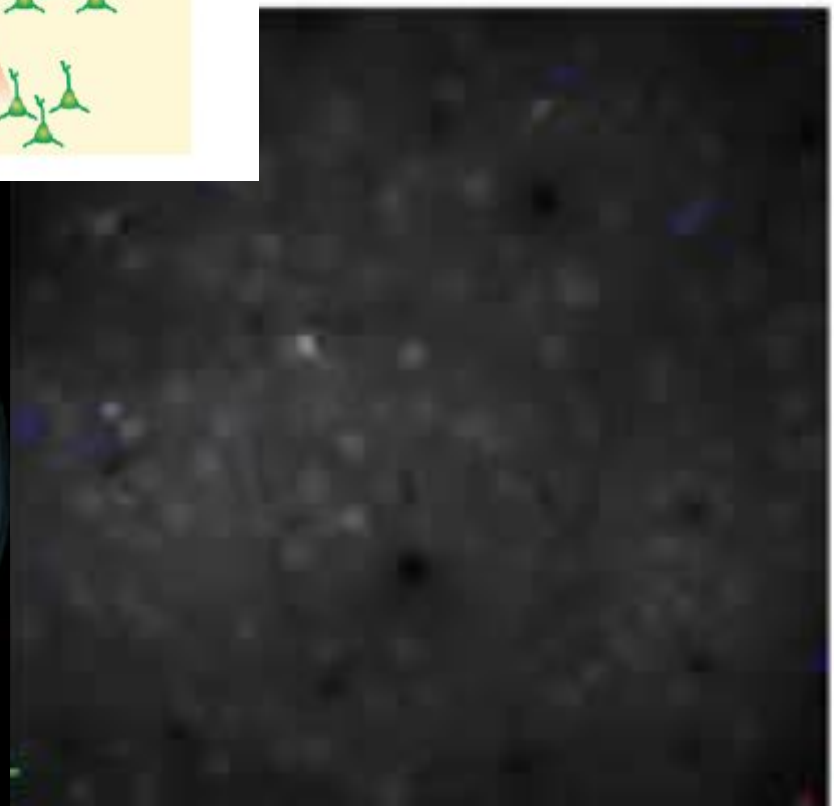
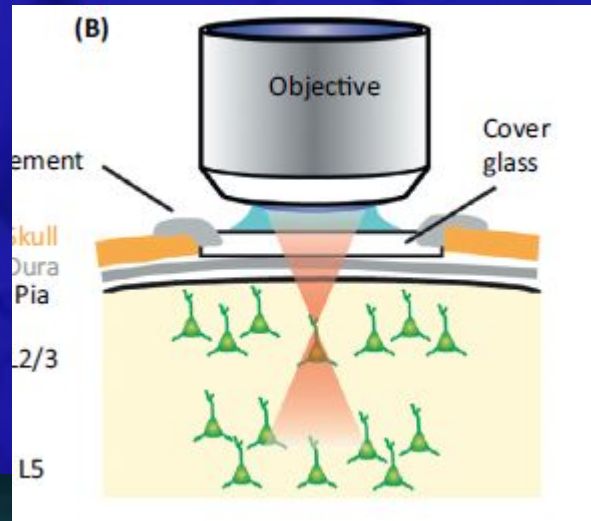

Whole-brain functional imaging at cellular resolution using light-sheet microscopy

Misha B Ahrens & Philipp J Keller

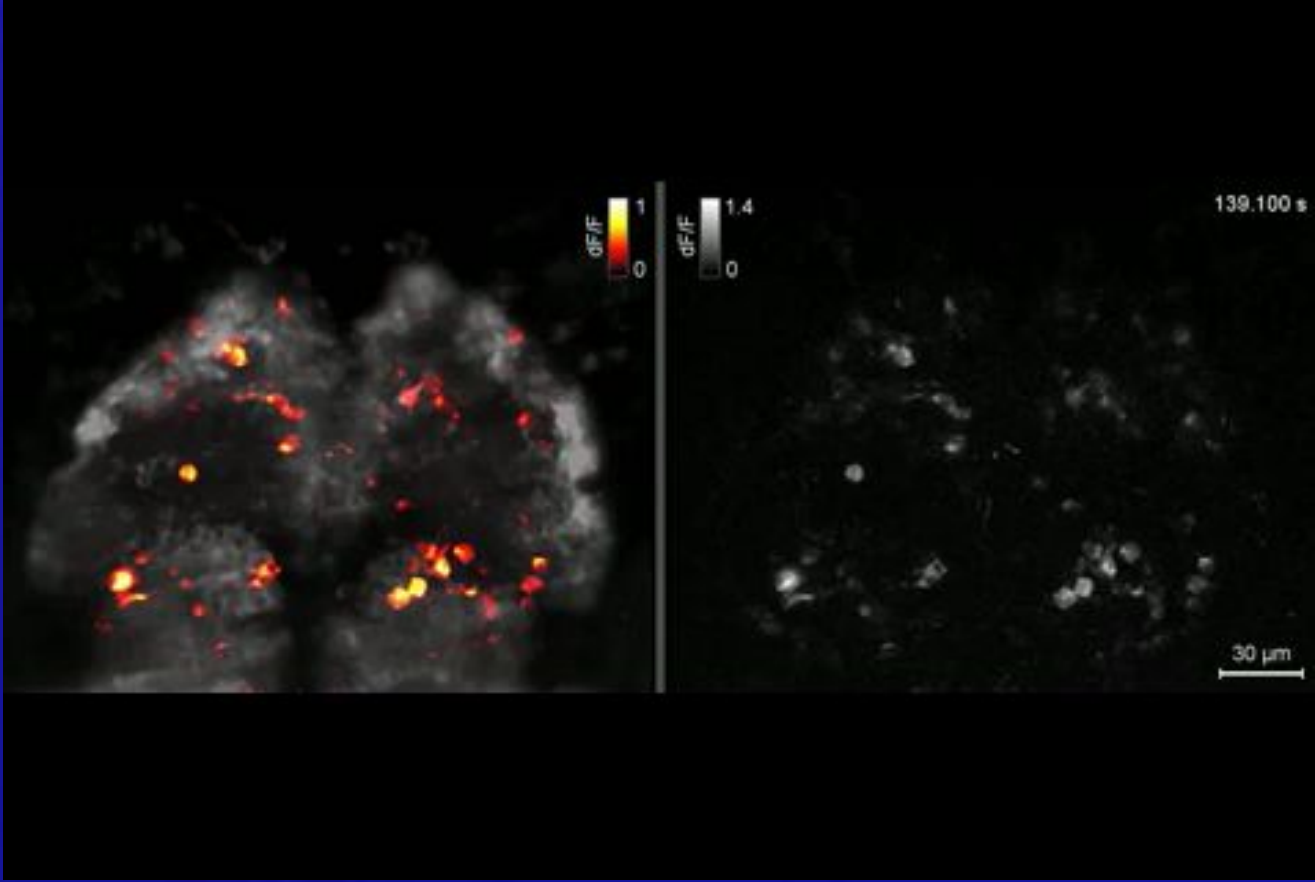
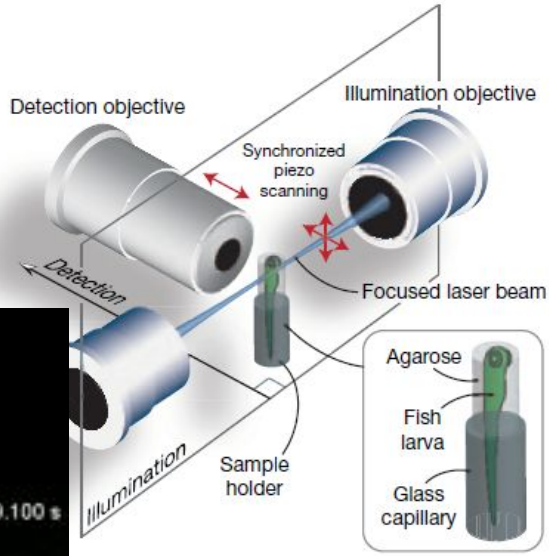

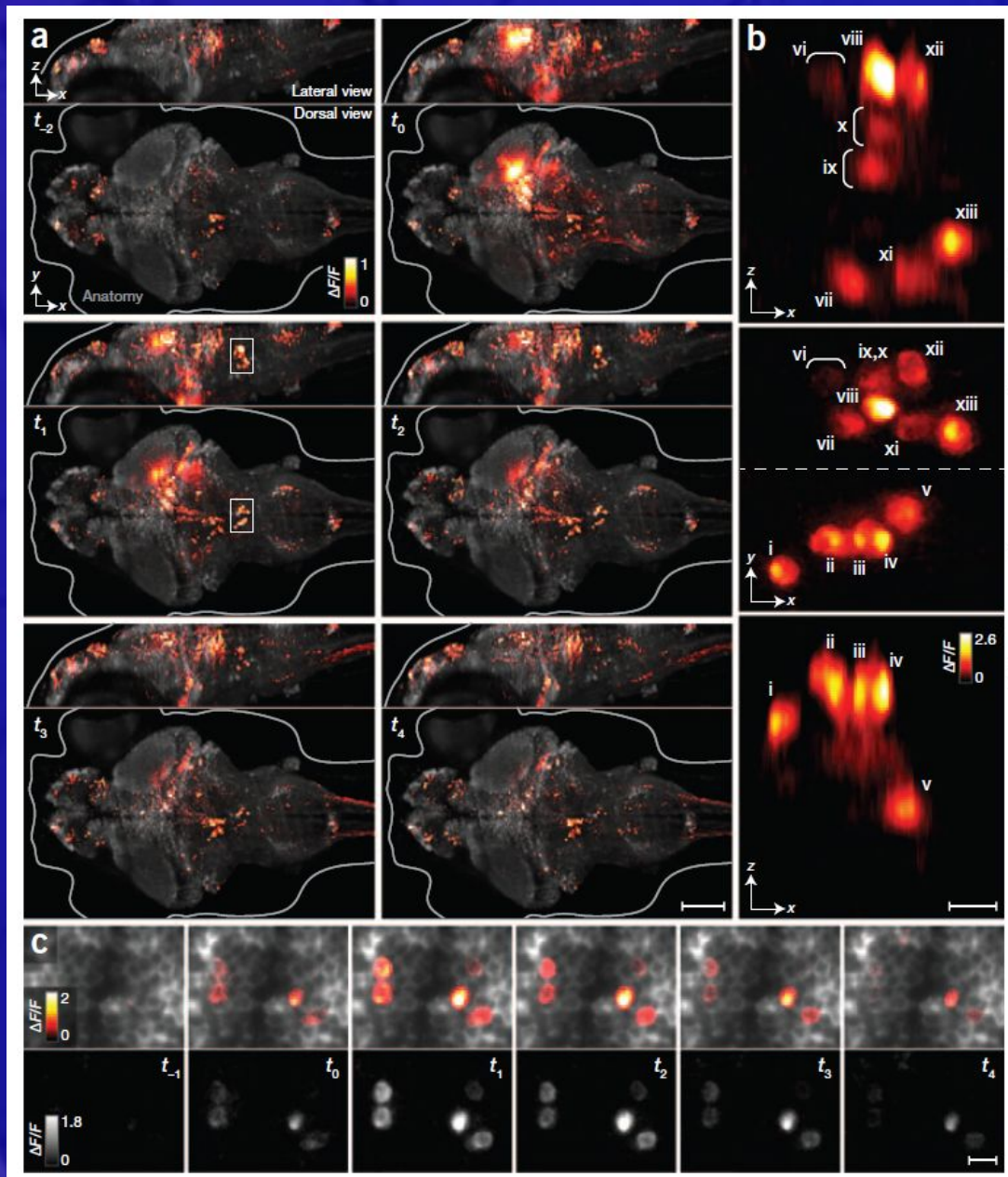

Нейроны различной селективности перемешаны

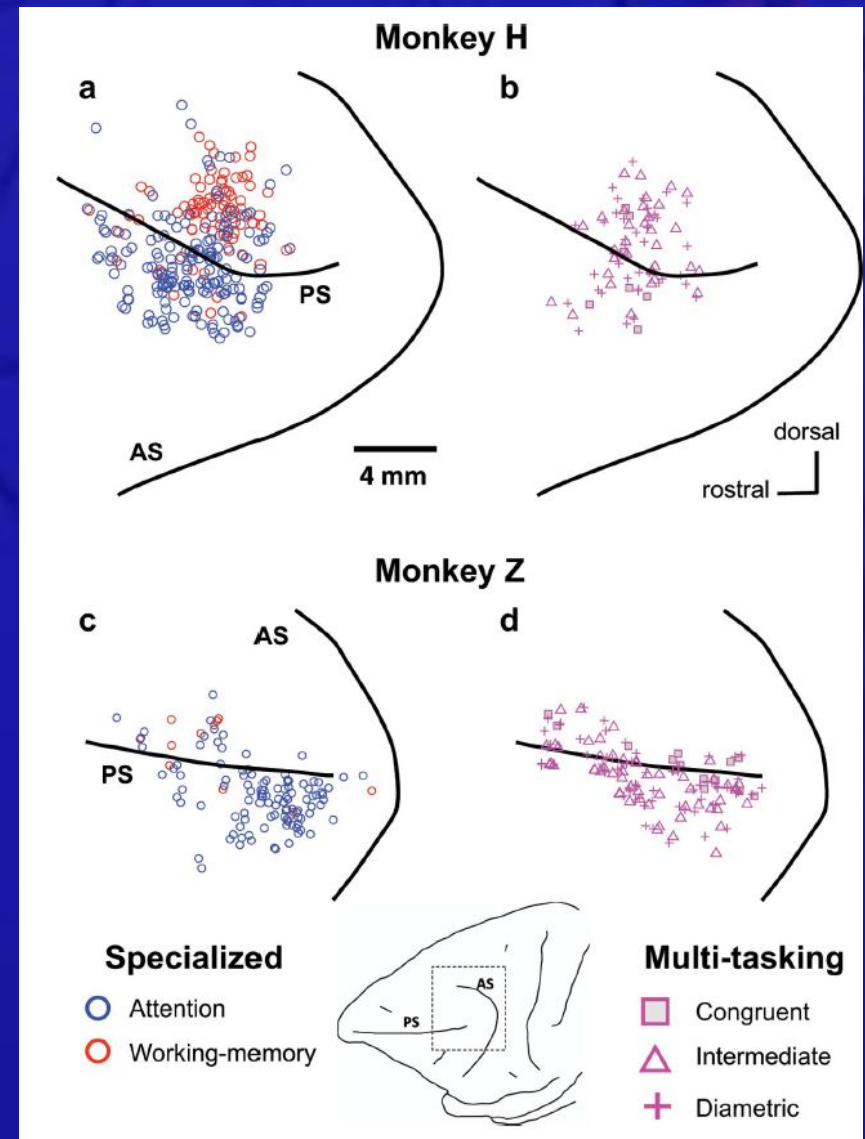
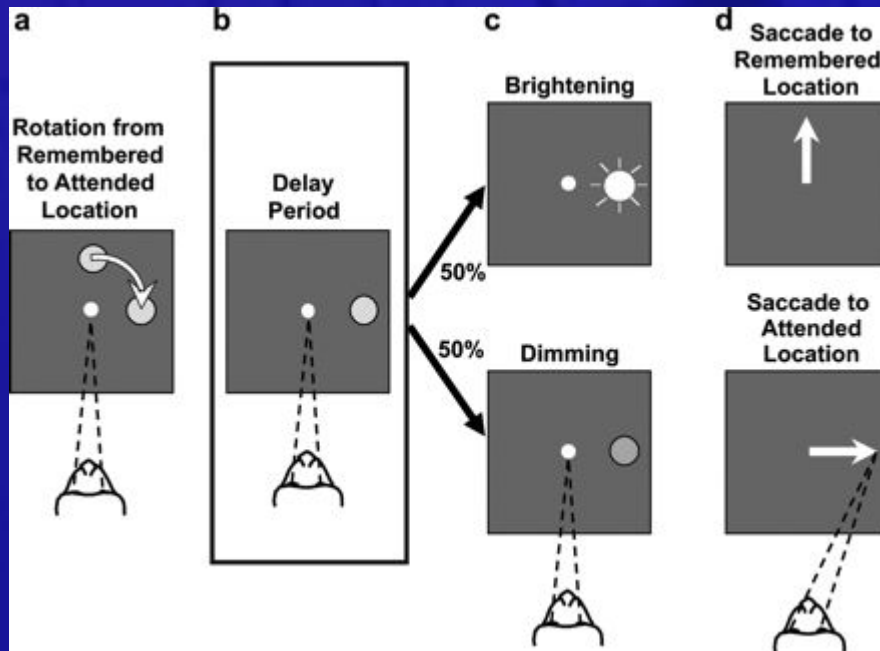

В любой момент времени можно выделить активную нейронную сеть

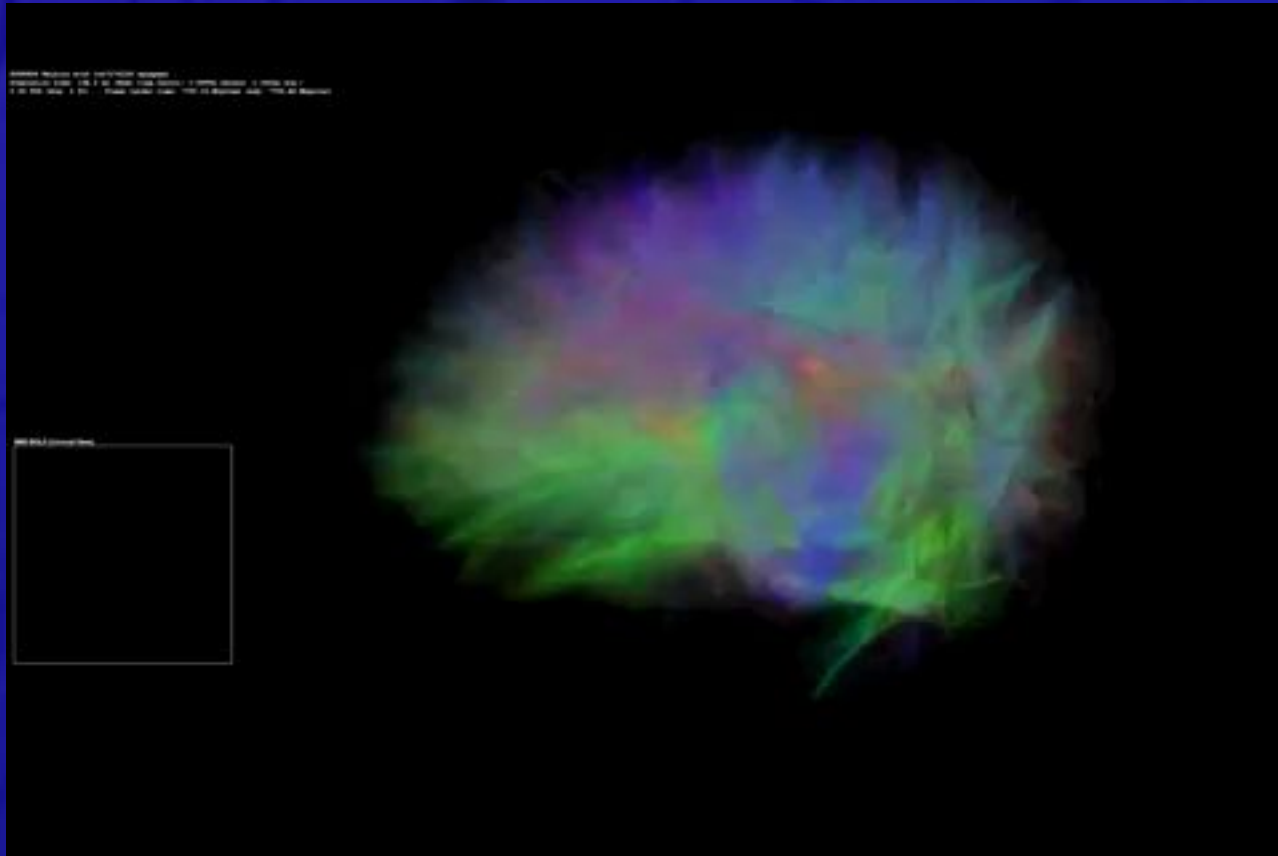

Можно выделить 2 представления об активности: активность синхронная и активность последовательная

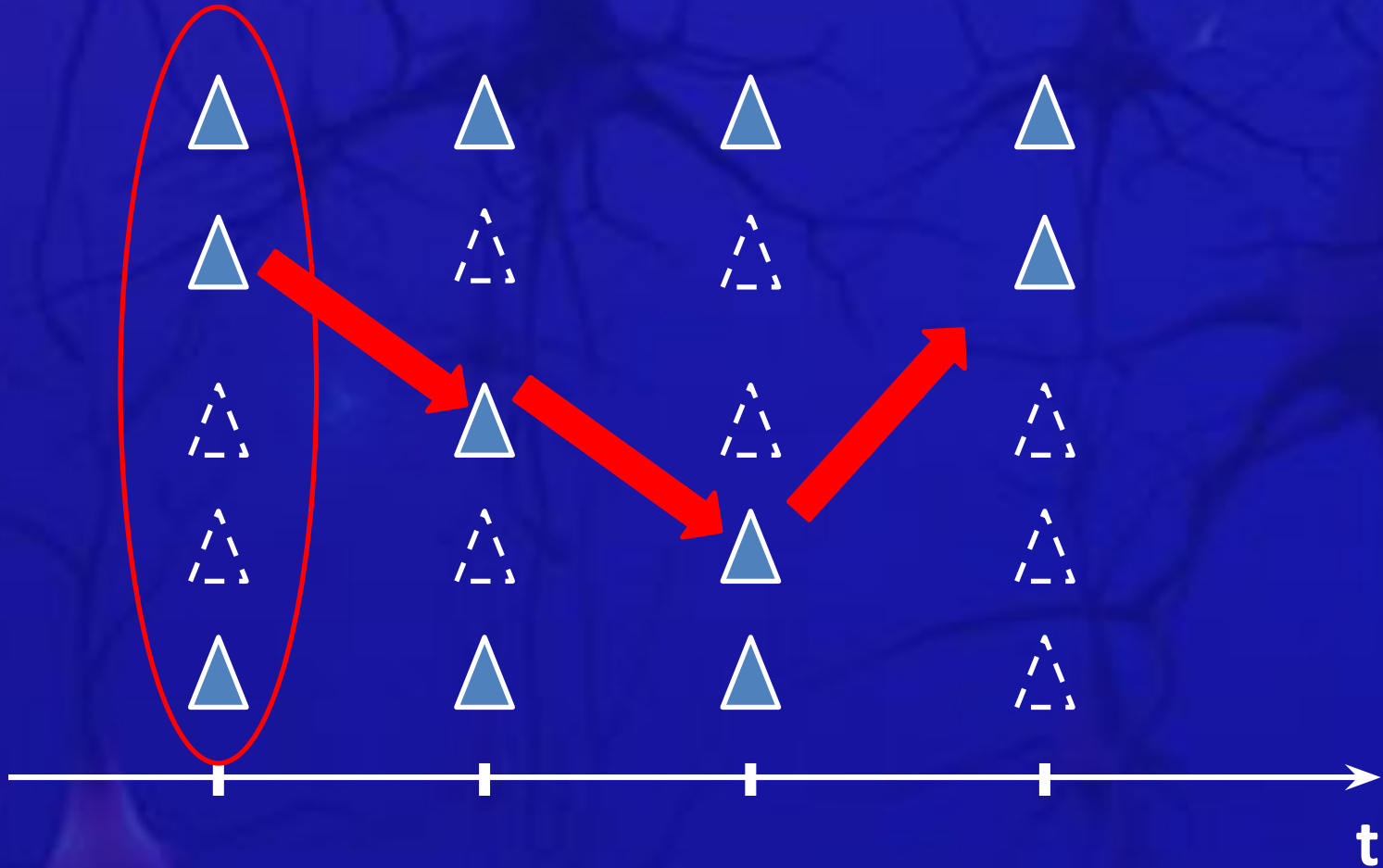

АКТИВНОСТЬ ОТДЕЛЬНЫХ НЕЙРОНОВ СВЯЗАНА С ТЕМ, ЧТО ДЕЛАЕТ ОРГАНИЗМ

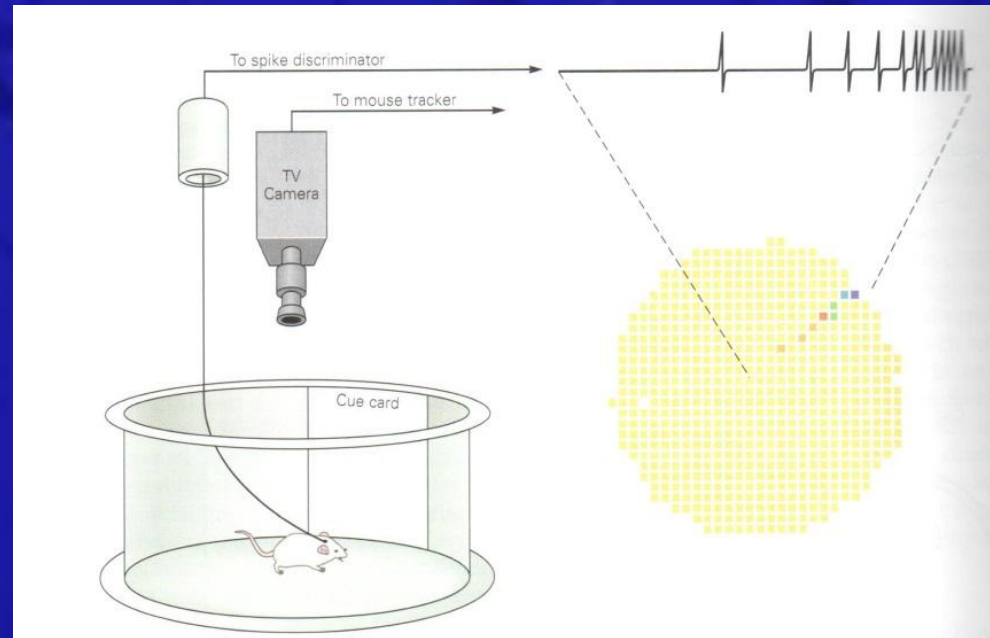
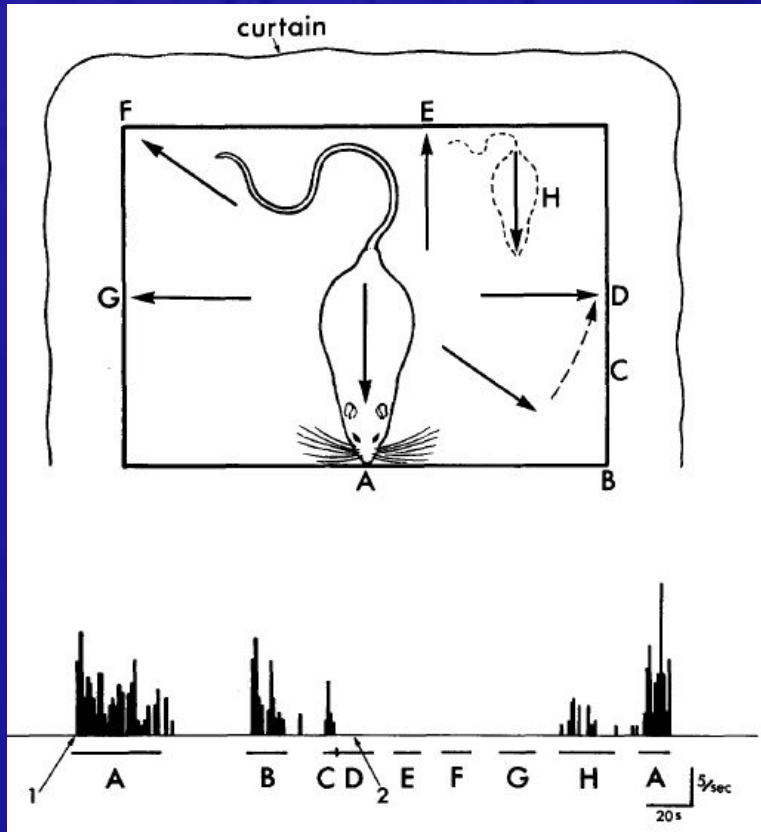

В активности нейронов наблюдается субъективность

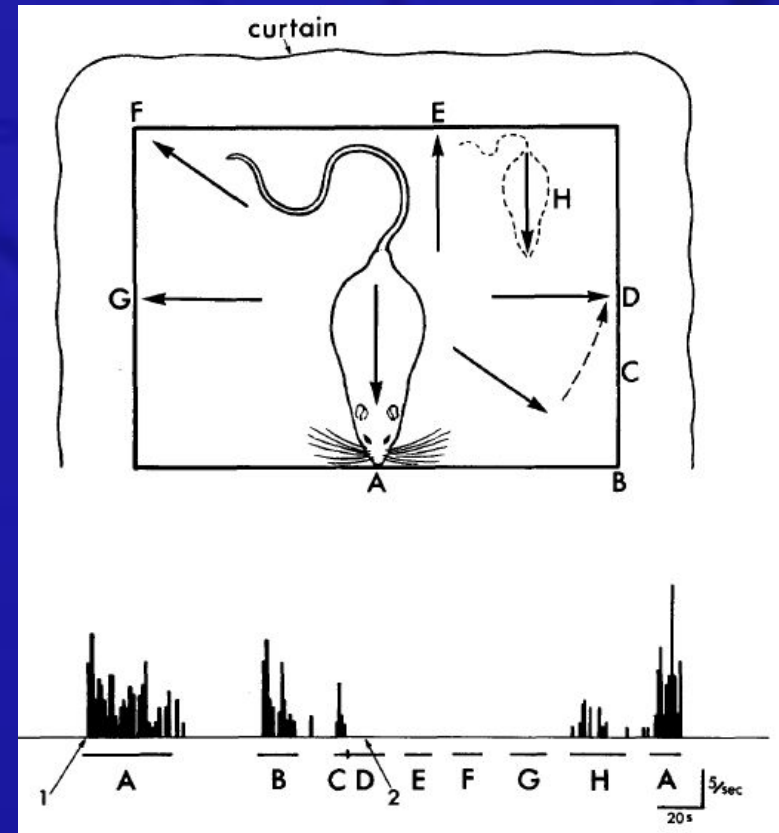
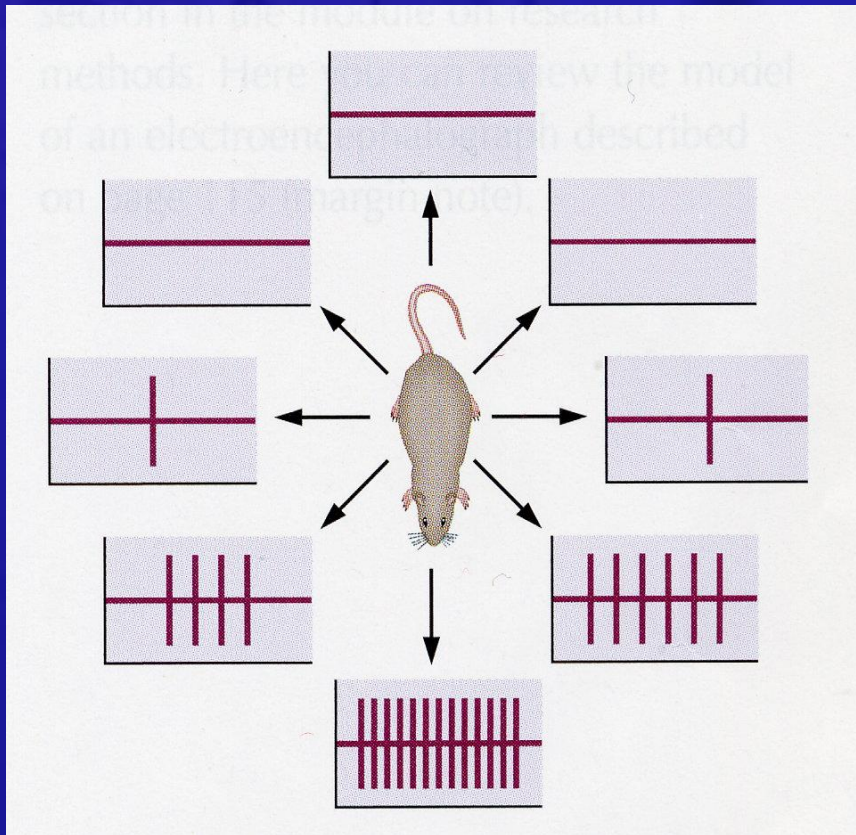

O'Keefe & Dostrovsky, 1971

13:44, 6 октября 2014

Присуждена Нобелевская премия по физиологии и медицине



Мэй-Бригг Мозер и Эдвард Мозер
Фото: The Kavli Institute at the NTNU / Wikipedia



Джон О'Киф
Фото: University College London

Нейроны «места»

**АКТИВНОСТЬ ОТДЕЛЬНЫХ НЕЙРОНОВ
СВЯЗАНА С ТЕМ, ЧТО ДЕЛАЕТ ОРГАНИЗМ**



Нейрон «крокодильчика»

Нейрон «моей бабушки»?

Brain Cells for Grandmother

Each concept—each person or thing in our everyday experience—may have a set of corresponding neurons assigned to it

*By Rodrigo Quian Quiroga,
Itzhak Fried and Christof Koch*

ЛЮБОЕ НАШЕ ПОВЕДЕНИЕ СОПРОВОЖДАЕТСЯ АКТИВНОСТЬЮ НАШИХ НЕЙРОНОВ

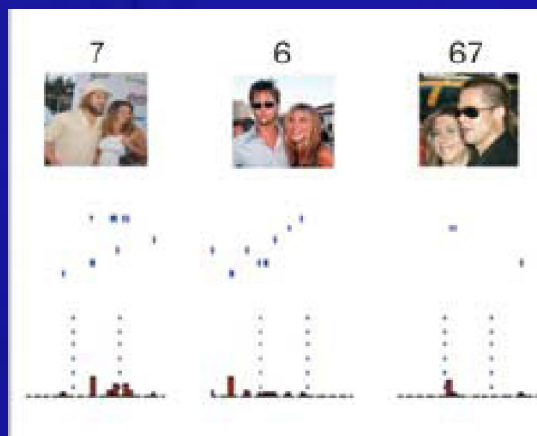
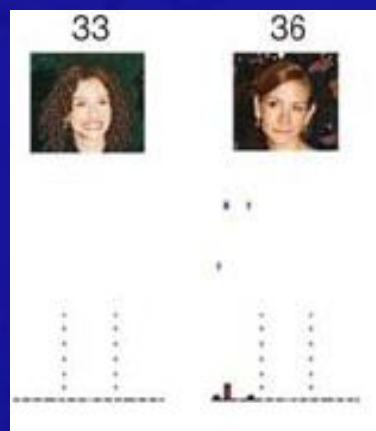
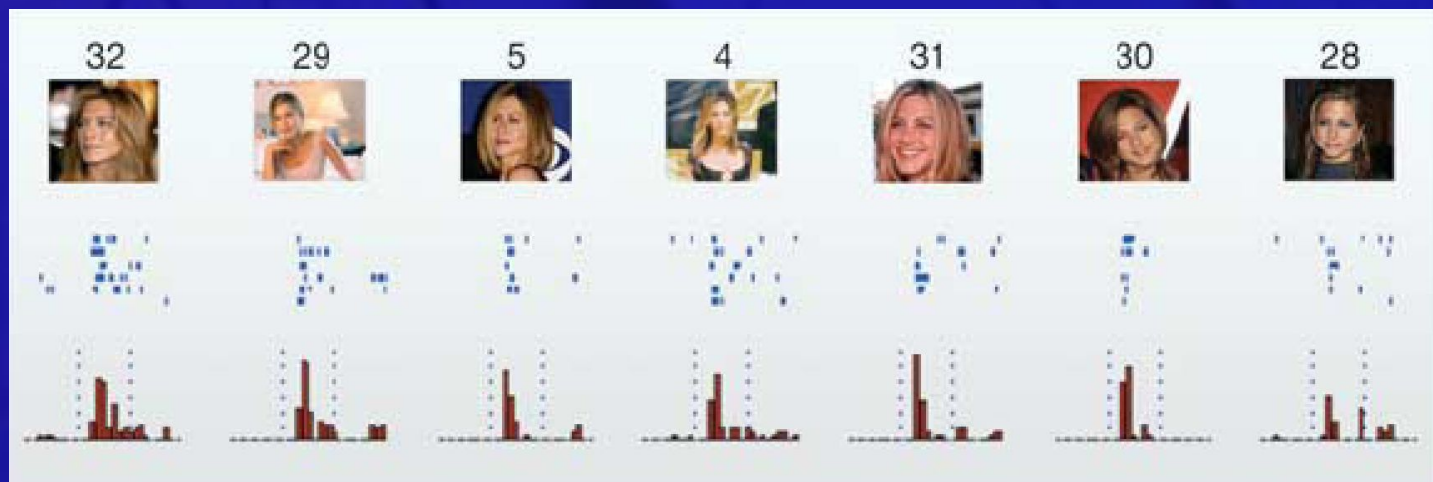

«ОКНО» ВО ВНУТРЕННИЙ МИР

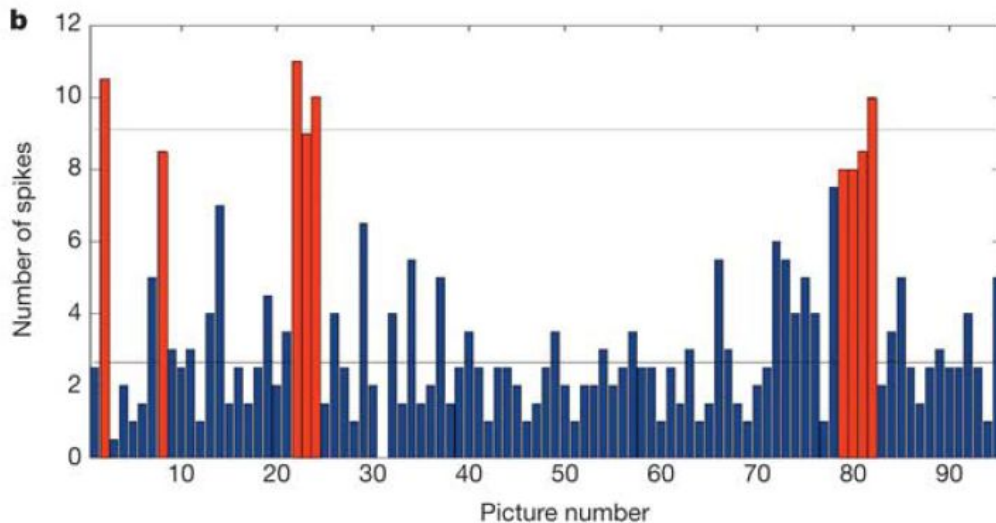
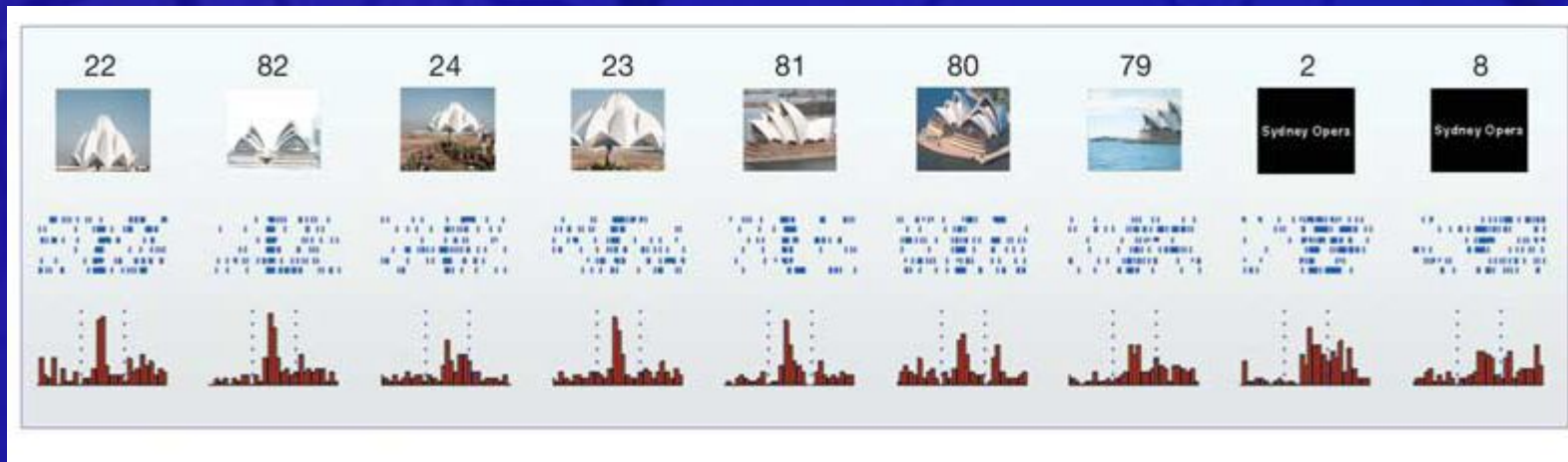

Figure 3 | A multi-unit in the left anterior hippocampus that responds to photographs of the Sydney Opera House and the Baha'i Temple (conventions as in Fig. 1). a–c, The patient identified all pictures of both of these buildings as the Sydney Opera, and we therefore considered them as a single landmark. This unit also responded to the presentation of the letter

string 'Sydney Opera' (pictures no. 2 and 8), but not to other strings, such as 'Eiffel Tower' (picture no. 1). In contrast to the previous two figures, this unit had a higher baseline firing rate (2.64 spikes). The area under the red curve in **c** is 0.97.

**ЛЮБОЕ НАШЕ ПОВЕДЕНИЕ - СУТЬ
АКТИВНОСТЬ НАШИХ НЕЙРОНОВ**

МЫ - АКТИВНОСТЬ НАШИХ НЕЙРОНОВ

Мы - это наш опыт, наша память, наши взаимодействия.

Как мы «добавляем в себя» что-то?

Активность нейронных групп складывается в процессе формирования индивидуального опыта

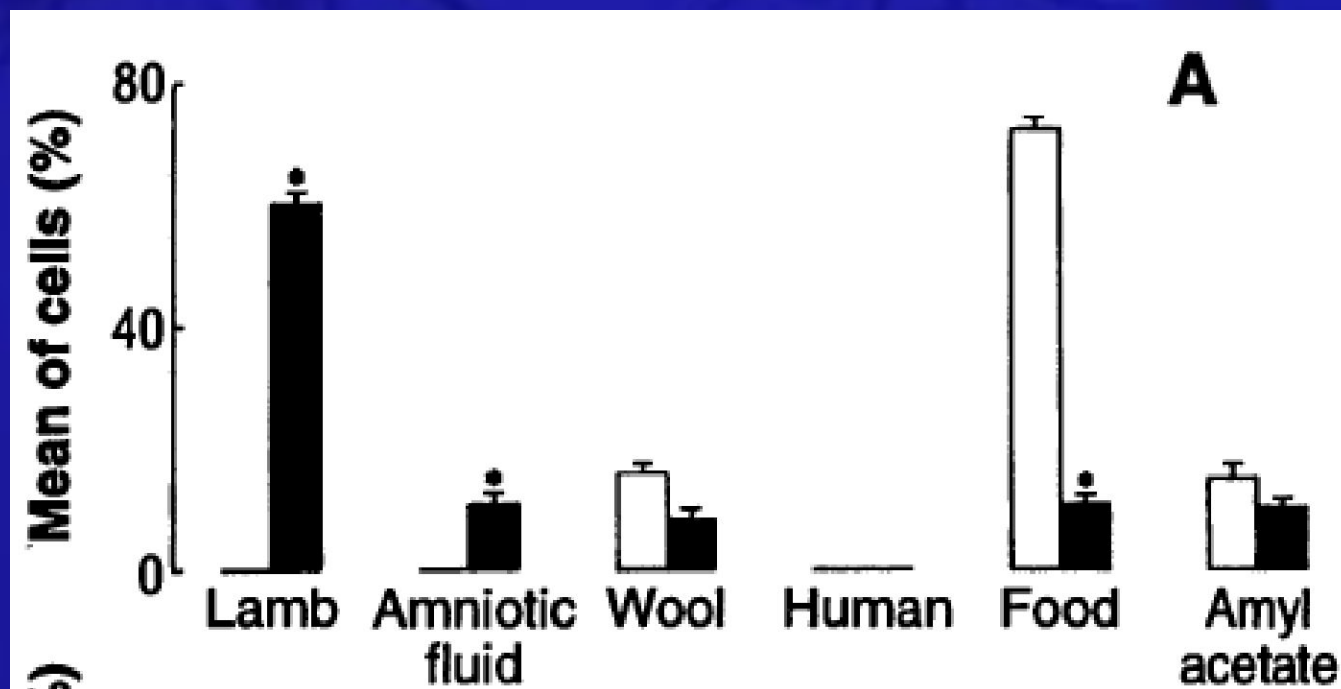

Kendrick et al., 1992

Рабочая память (кратковременная память) – поддержание активности нейронной группы

➤ травмы

➤ судороги

АМНЕЗИИ



РАЗВИТИЕ

Источник новых нейронов – молчащие и новые клетки

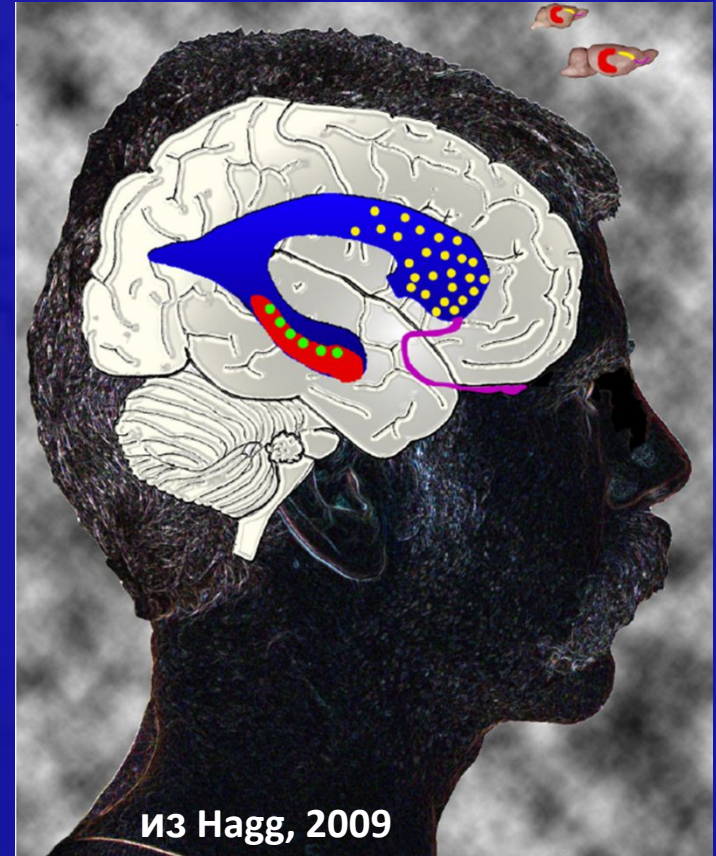
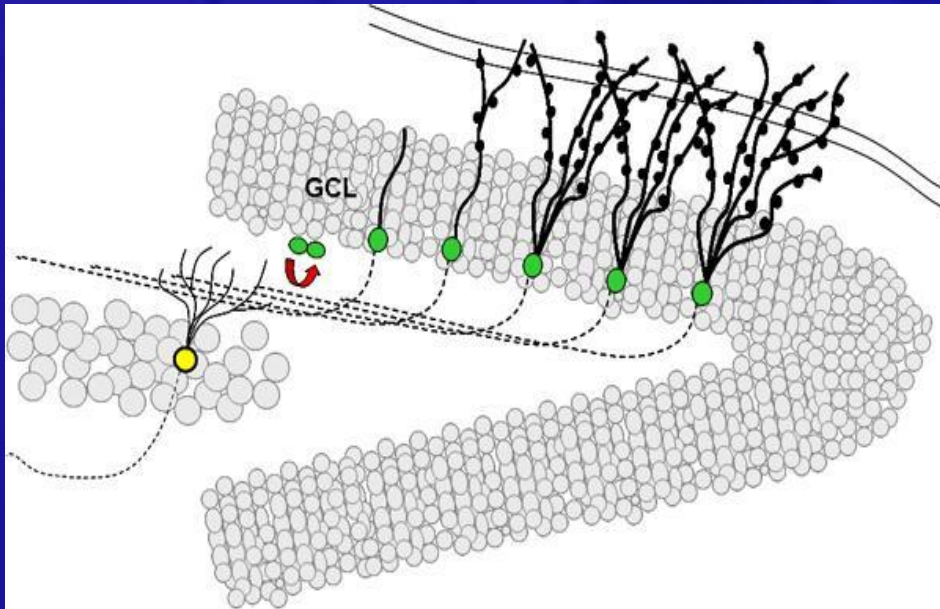

Нейрогенезу способствуют

- ✓ обогащенная среда
- ✓ обучение
- ✓ «спортивный образ жизни»

Встраивание новых нейронов

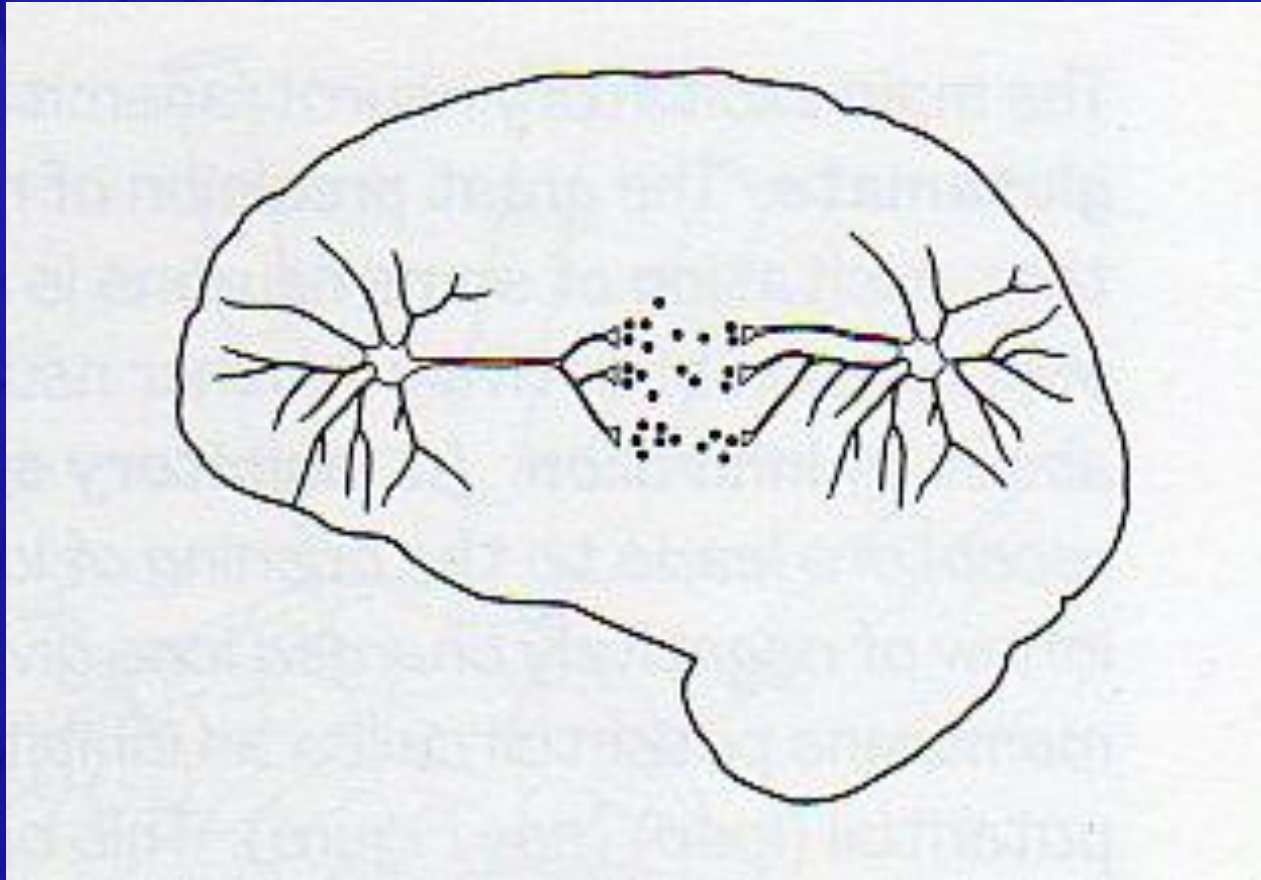

Каскады молекулярных событий внутри нейронов

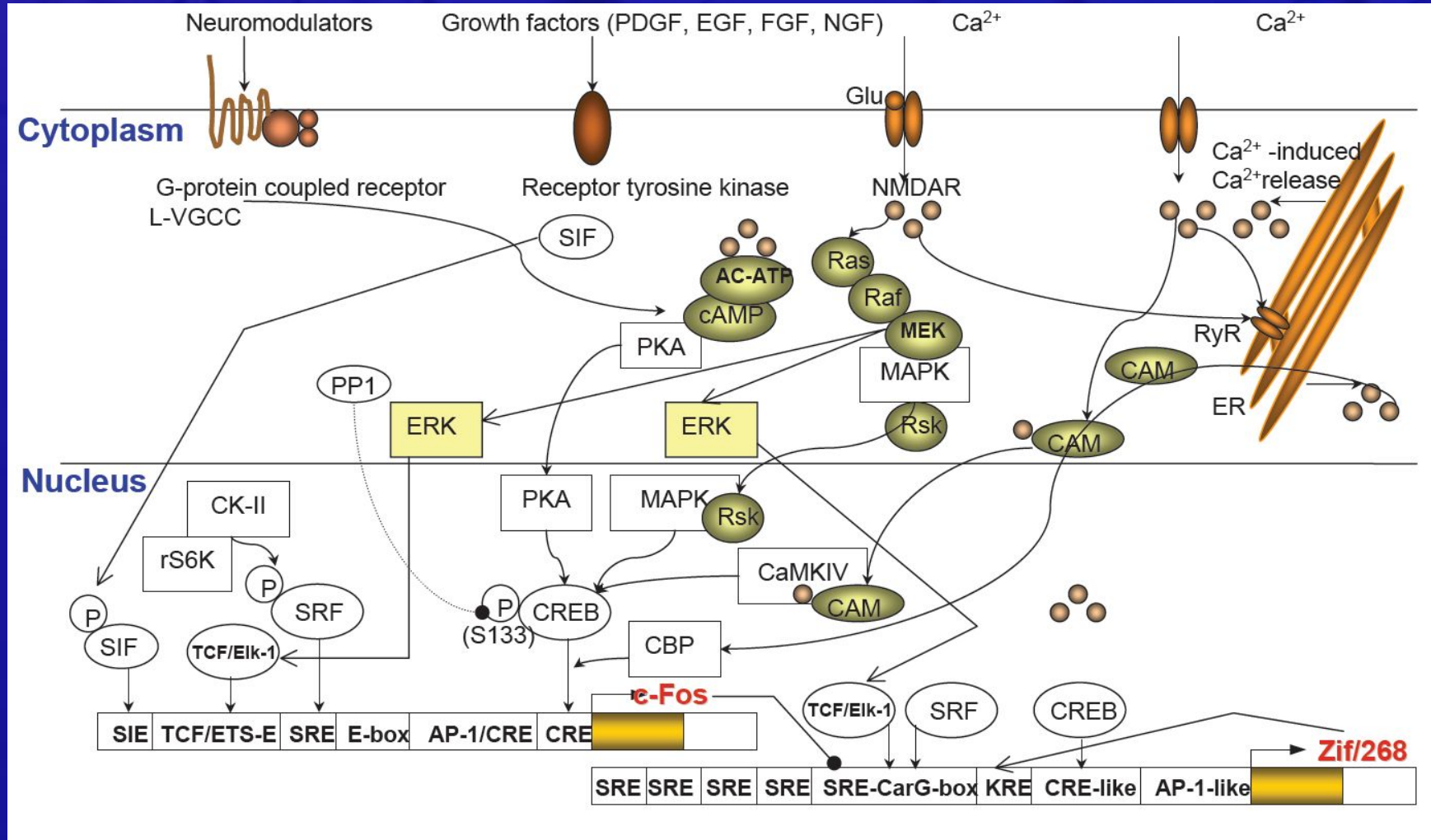

У нейрона много видов активности

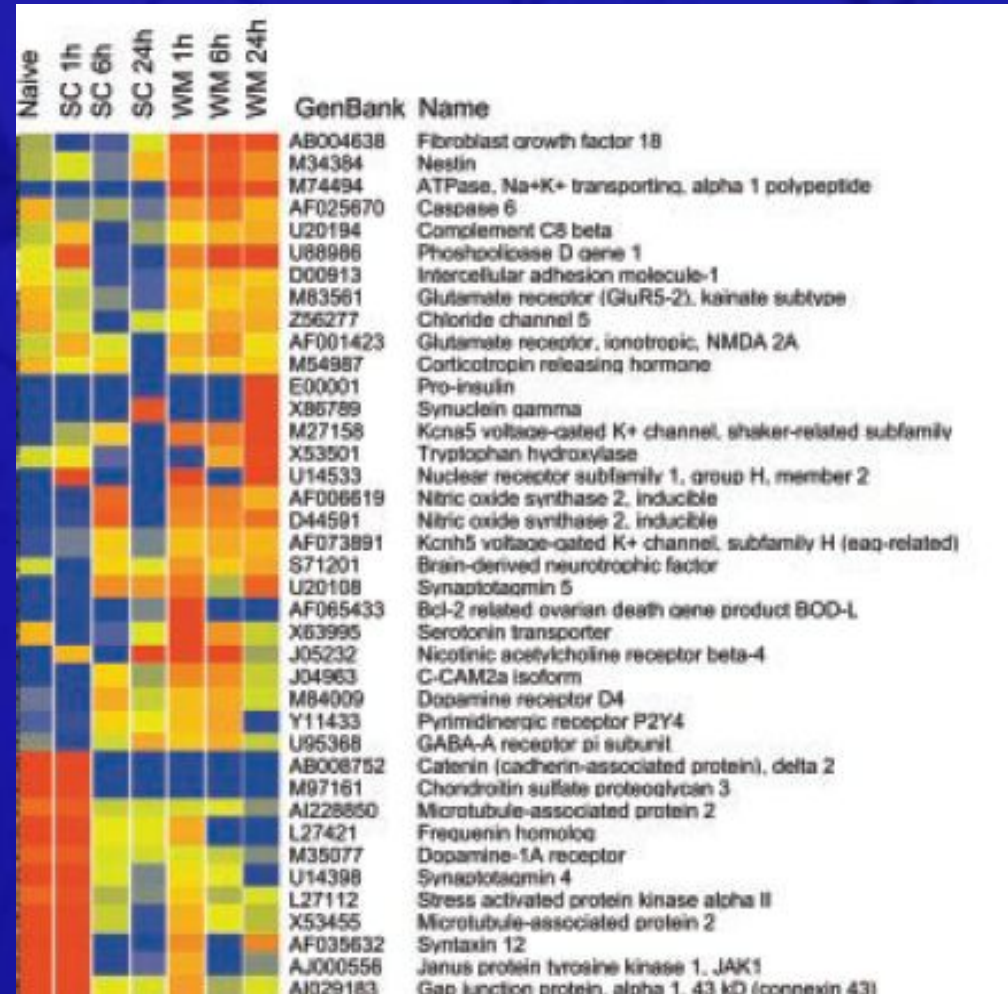
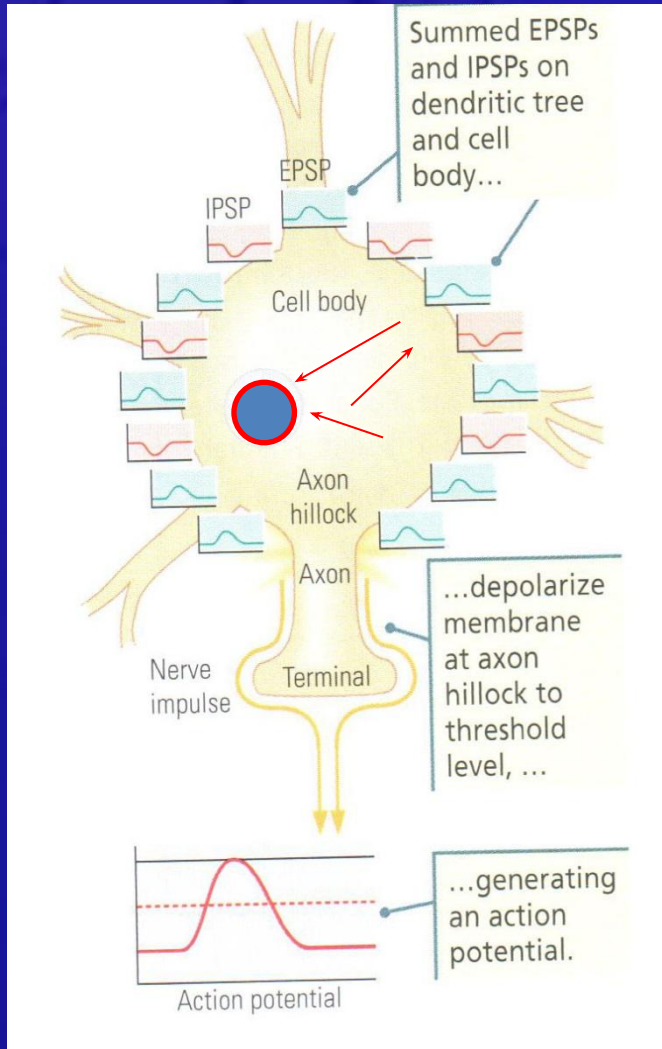

Структурные изменения

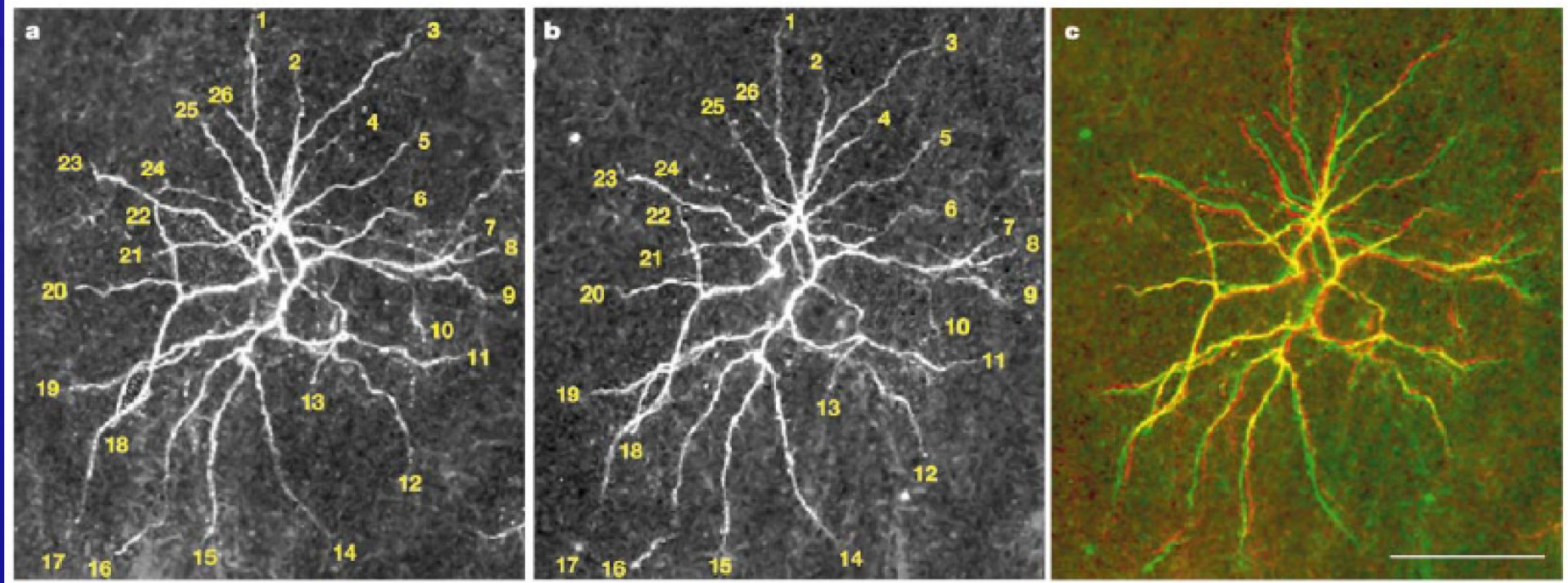

Изменение количества шипиков на дендритах при обучении

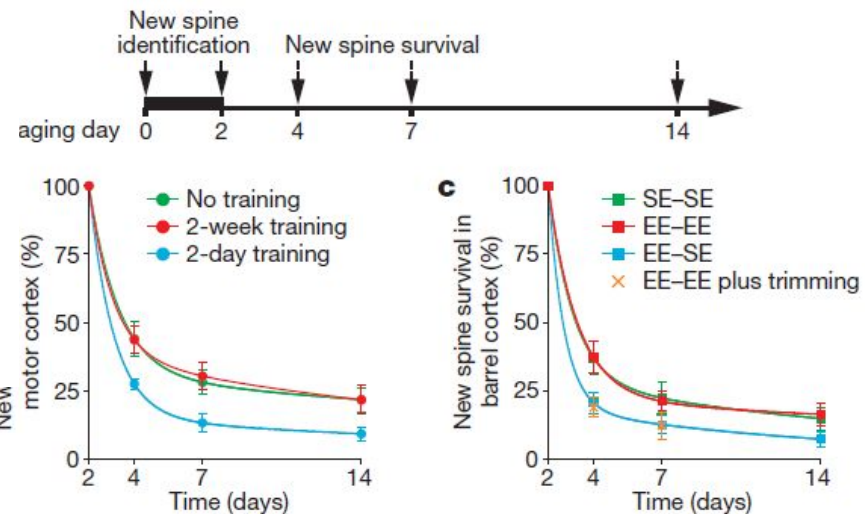
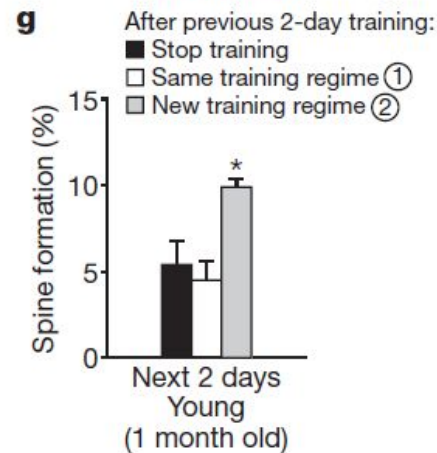
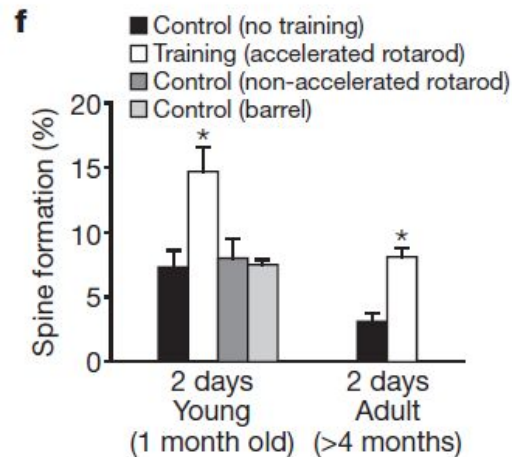
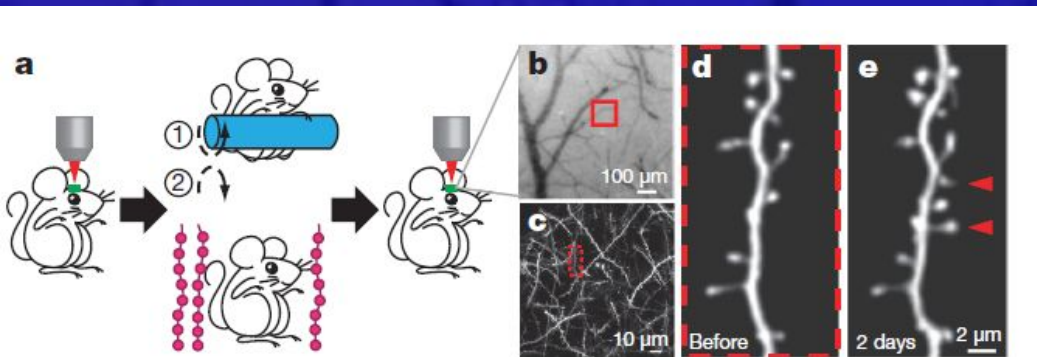

Stably maintained dendritic spines are associated with lifelong memories

Yang et al., 2009

Обучение - формирование новых нейронных групп

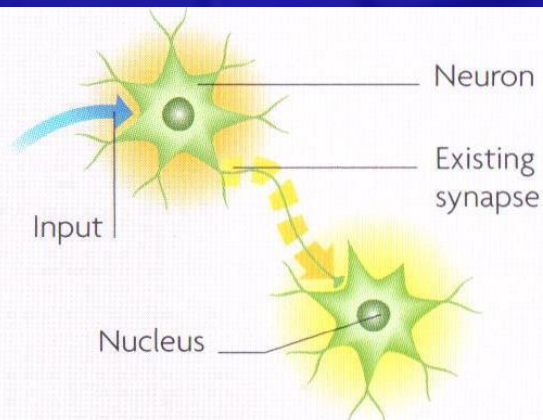

1 INPUT

An external stimulus triggers two neurons to fire simultaneously. In future, if one fires, the other is likely to fire, too.

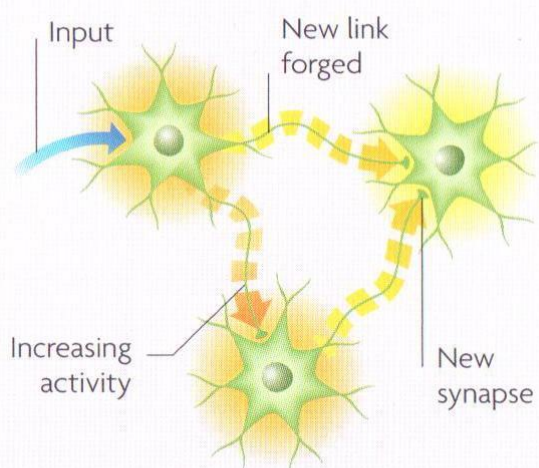

2 CIRCUIT FORMATION

A third neuron fires. One of the initial pair is stimulated to fire with it, triggering the second, so the three become linked.

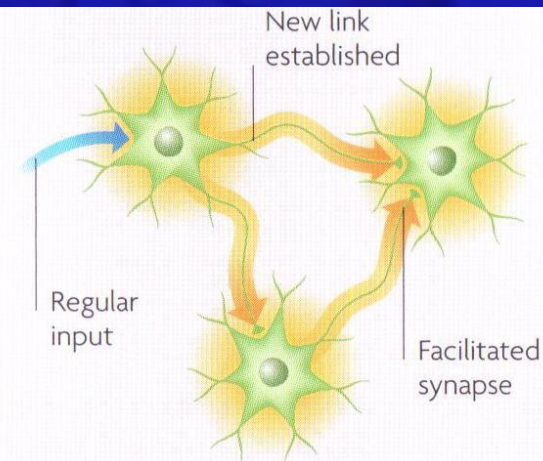

3 INCREASING ACTIVITY

The three neurons are now sensitized to one another, so that if one fires, the other two are likely to fire as well.

(a) Newborn

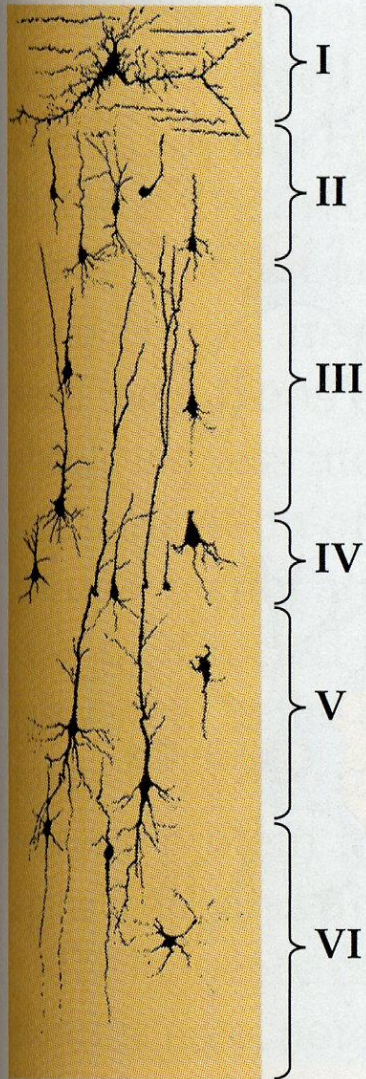

(b) Three-month-old

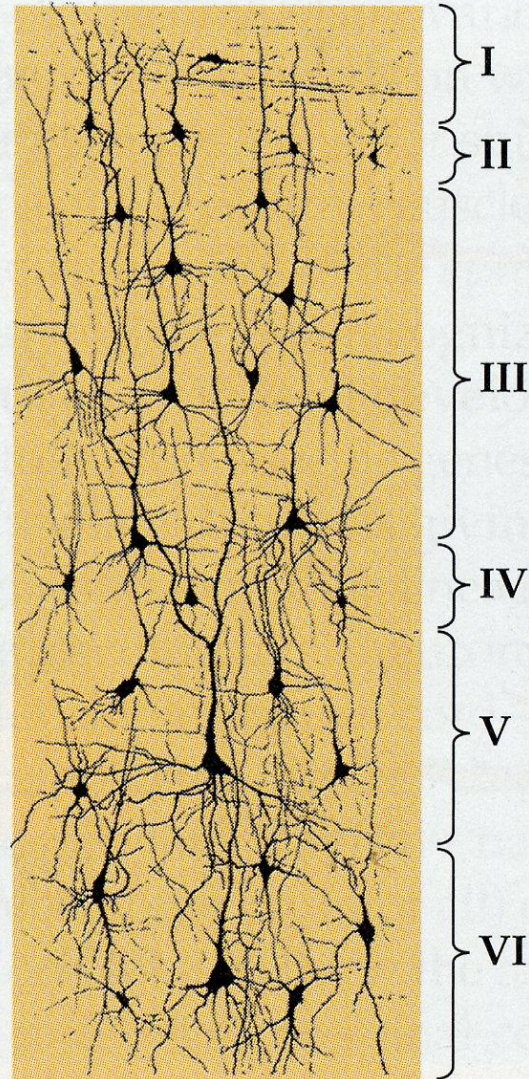

(c) Two-year-old

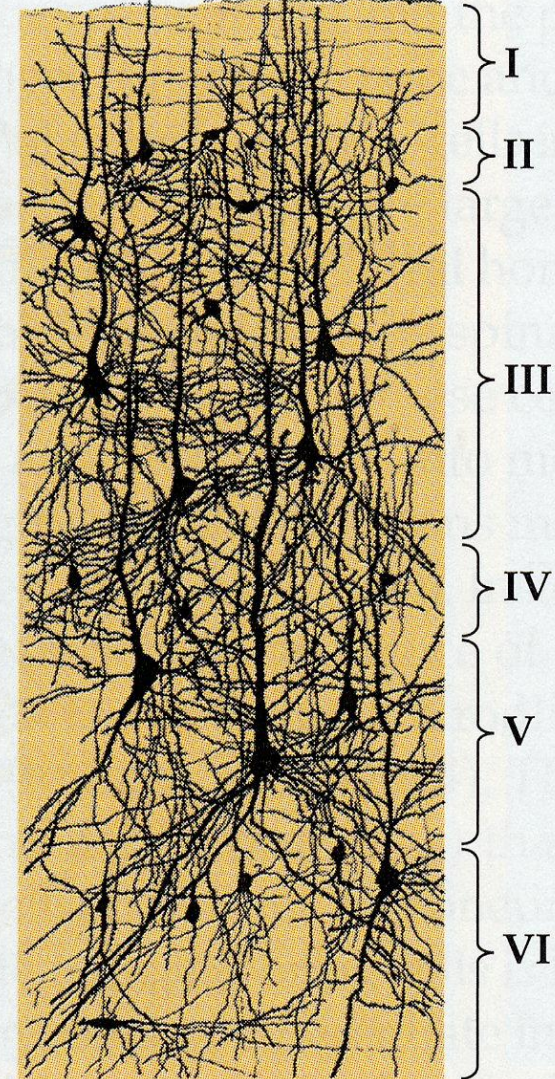

7.7 Cerebral Cortex Tissue in the Early Development of Humans

Ранний онтогенез

(A)

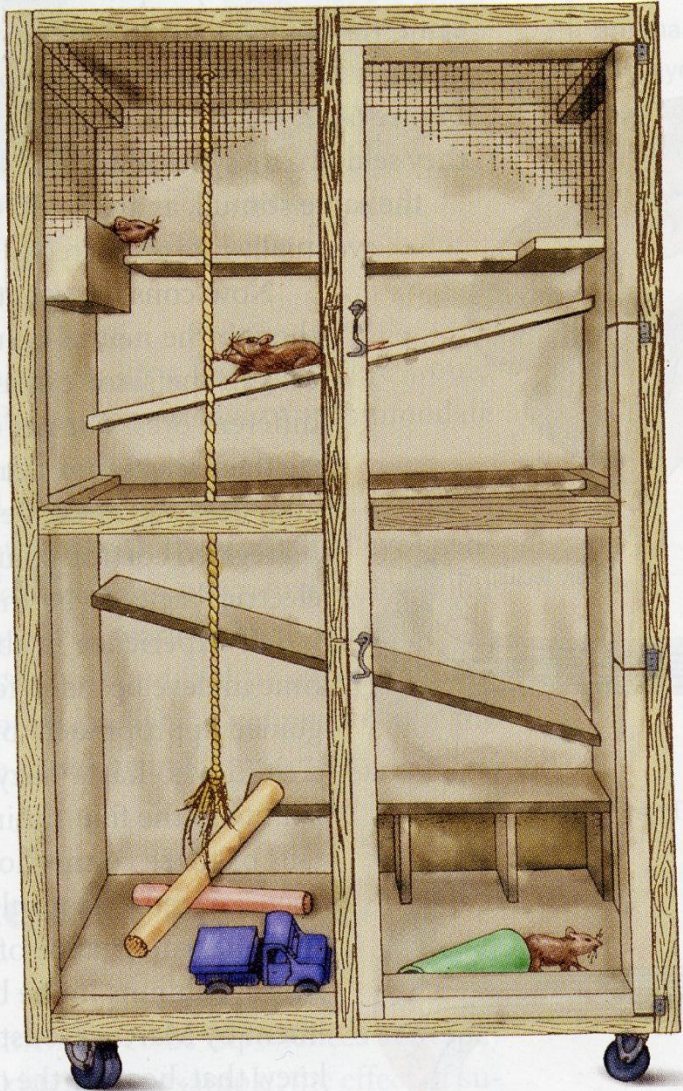

(B)

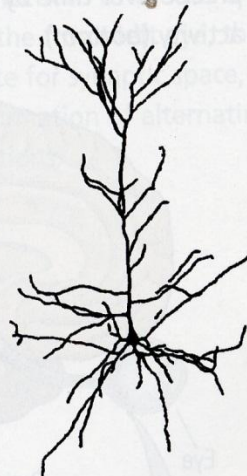

Laboratory housed

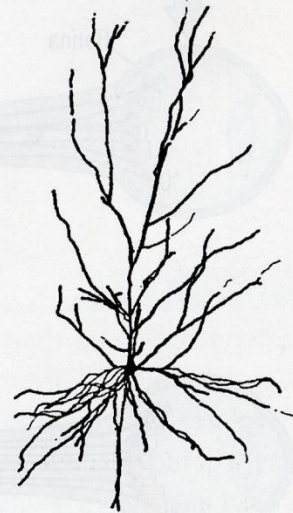

Complex-environment housed

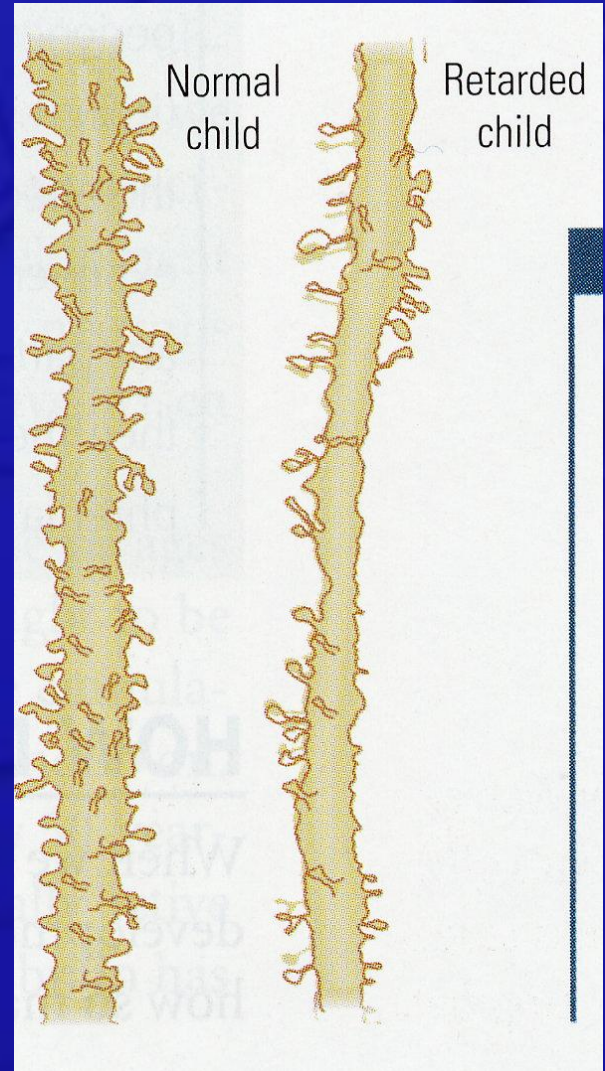

Болезнь Альцгеймера

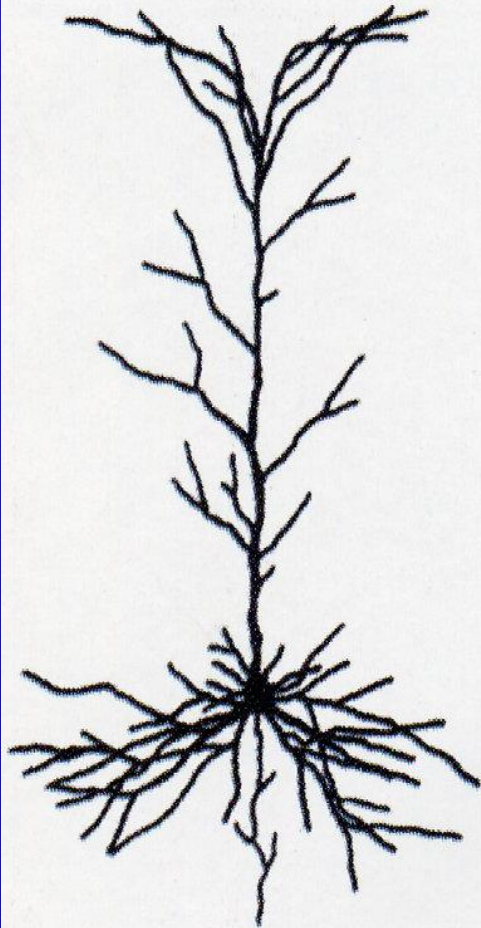

Normal adult
pattern

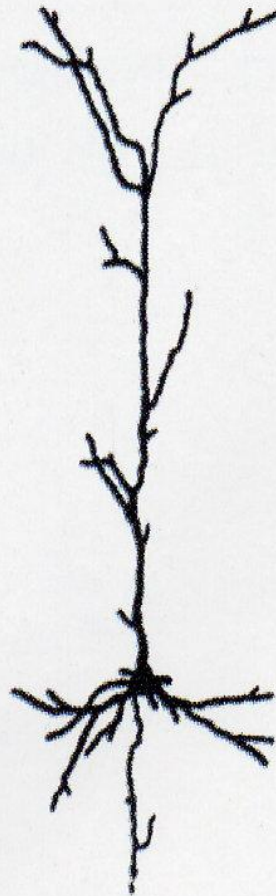

Early
Alzheimer's
disease



Advanced
Alzheimer's
disease



Terminal
Alzheimer's
disease

THE PRINCIPLES OF MEMORY

MEMORY IS A BROAD TERM USED TO REFER TO A NUMBER OF DIFFERENT BRAIN FUNCTIONS. THE COMMON FEATURE OF THESE FUNCTIONS IS THE RE-CREATION OF PAST EXPERIENCES BY THE SYNCHRONOUS FIRING OF NEURONS THAT WERE INVOLVED IN THE ORIGINAL EXPERIENCE.

... воссоздание прошлого опыта посредством синхронной активации тех нейронов, которые были активны в момент первого переживания этого опыта.

R. Carter, 2009

Мысленное воспоминание – реактивация определенных нейронов

viewing session

demonstration for Fig. 1

Firing of a single entorhinal
cortex neuron while watching
short video episodes

Beeps represent single spikes

Феномен реконсолидации (непрерывной реорганизации памяти)

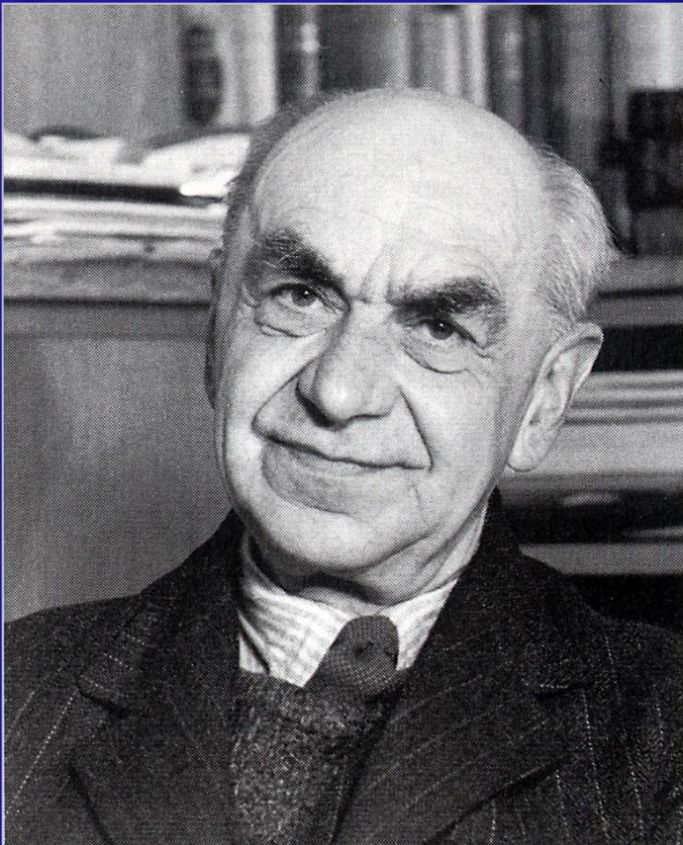

Фредерик Бартлетт
1886-1969

"Я настаивал на протяжении всей дискуссии в этой книге на том, что описание воспоминаний как "фиксированных и безжизненных" есть всего лишь ошибочная фантазия.

Воспоминание не является повторным возбуждением неисчислимых фиксированных фрагментарных следов. Оно есть всегда творческое воссоздание или конструирование, складывающееся из нашего отношения ко всей активной массе реакций и опыта прошлого."

1932

**Последовательное описание
картины**

Pluto behaving badly: False beliefs and their consequences

AMERICAN JOURNAL OF PSYCHOLOGY
Winter 2008, Vol. 121, No. 4, pp. 645–662

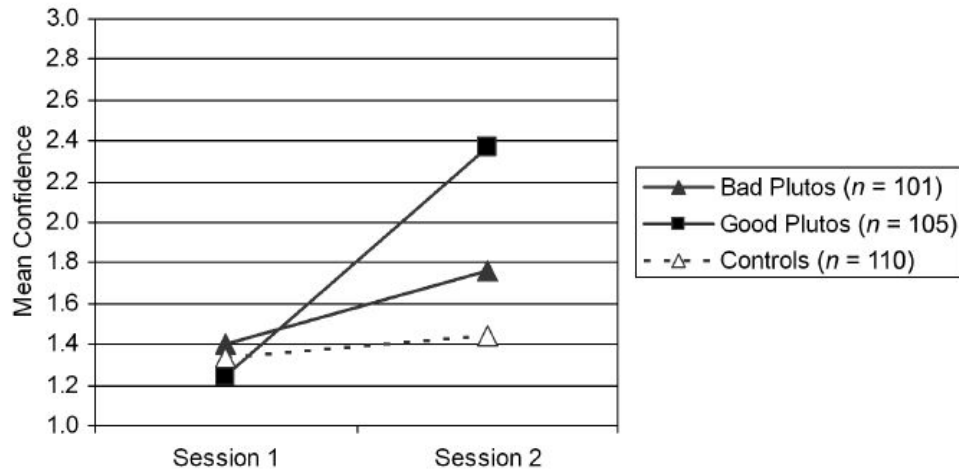
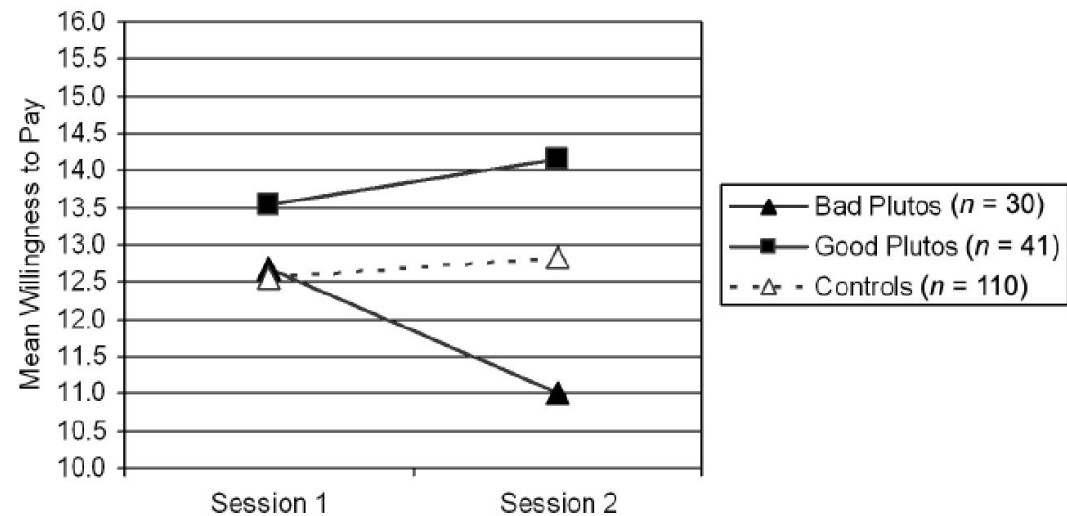

Figure 1. Mean confidence ratings of the critical item (“You had your ear licked by Pluto”) on the Disneyland Questionnaire, before and after manipulation



СТИМУЛЯЦИЯ НЕЙРОННОЙ АКТИВНОСТИ - ВОЗНИКНОВЕНИЕ ПОВЕДЕНИЯ



Если бы нейроны не были селективны в своей активности, мы бы не наблюдали специфического поведения при стимуляции

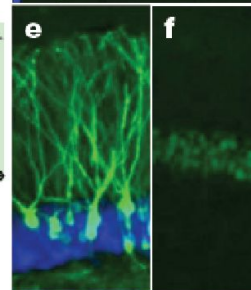
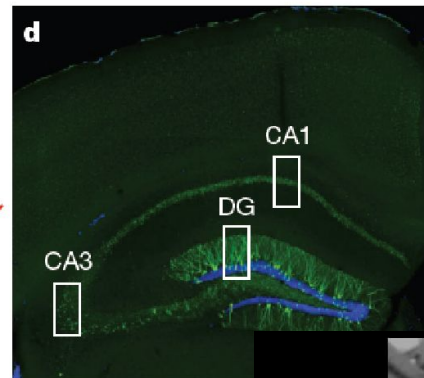
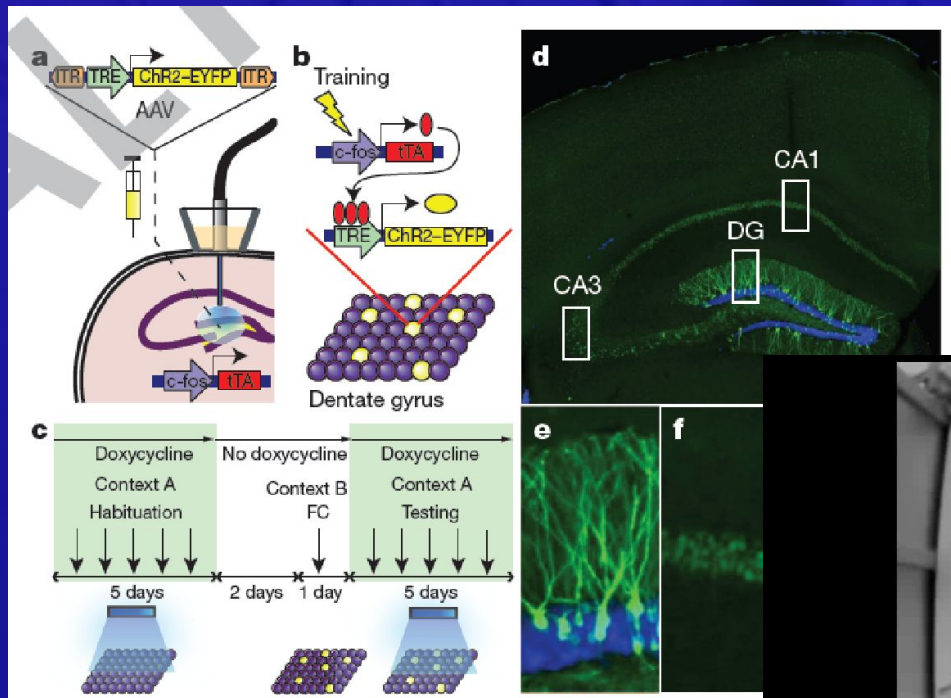

Направленное создание памяти

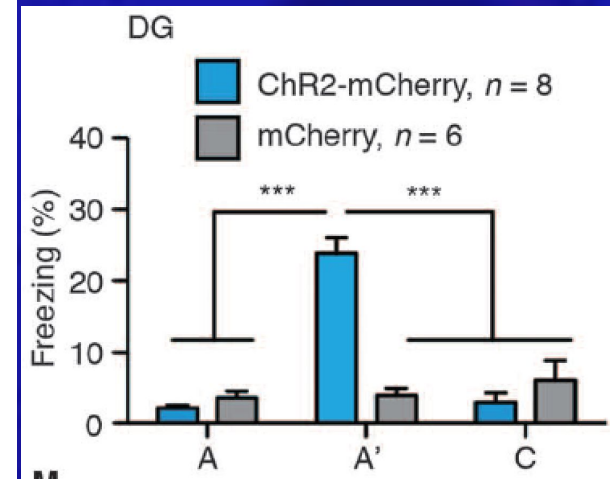
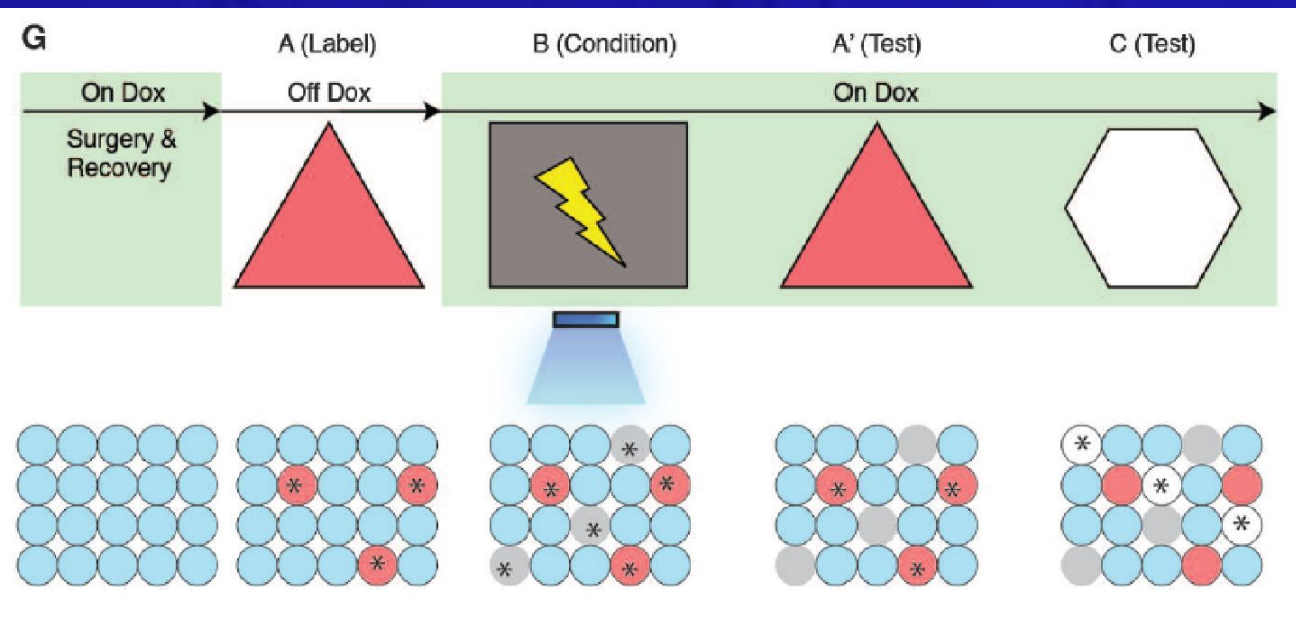
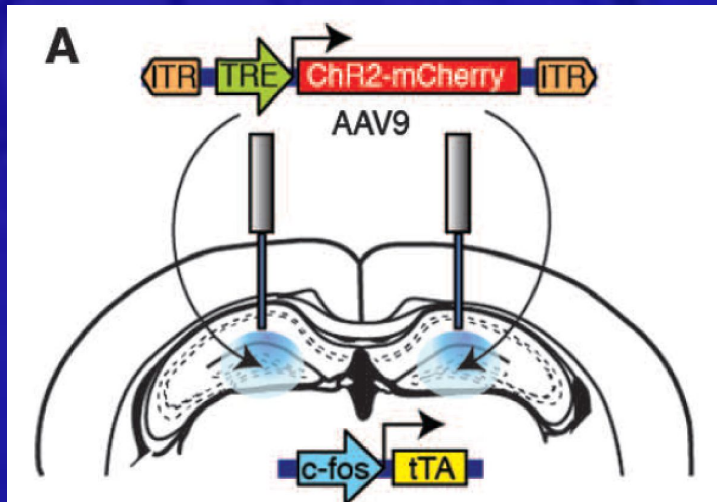

Sparse

Image of
Luke Skywalker

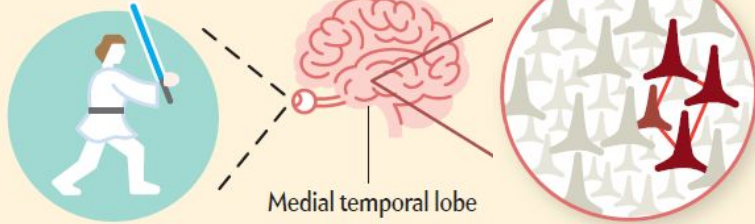

Different image of
Luke Skywalker



Image of
Yoda



Image of
Jennifer Aniston



Весь наш опыт – группы нейронов

Rodrigo Quian Quiroga, a native of Argentina, is professor and head of the Bioengineering Research Group at the University of Leicester in England. He is author of the recently published *Borges and Memory: Encounters with the Human Brain* (MIT Press, 2012).



Itzhak Fried is a professor of neurosurgery and director of the Epilepsy Surgery Program at the U.C.L.A. David Geffen School of Medicine. He is also a professor at the Tel Aviv Sourasky Medical Center and Tel Aviv University.



Christof Koch is professor of cognitive and behavioral biology at the California Institute of Technology and chief scientific officer at the Allen Institute for Brain Science in Seattle.





Лирическое
отступление №1

Prosser and Hunter, 1936

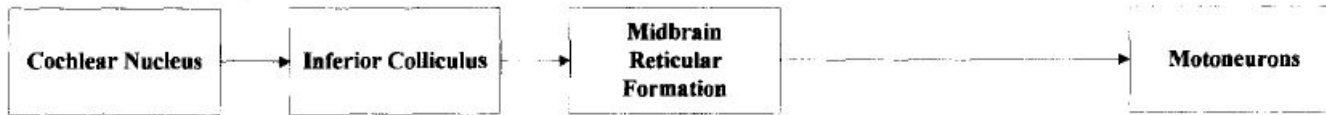

Davis et al., 1982

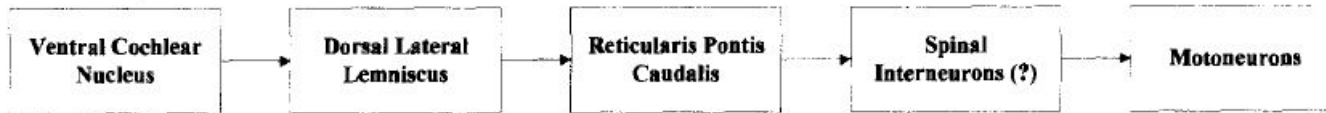

Pellet, 1990

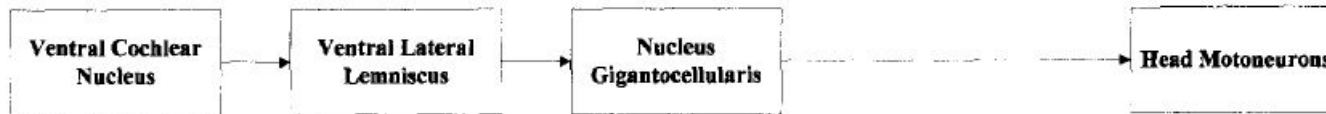

Kandler and Herbert, 1991



Lingenhohl and Friauf, 1994

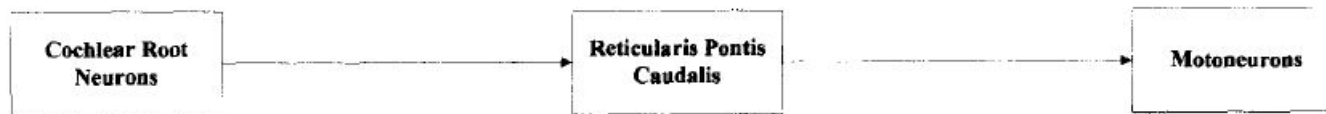

Yeomans and Frankland, 1996

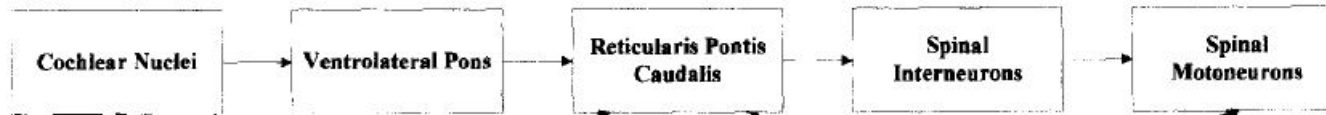

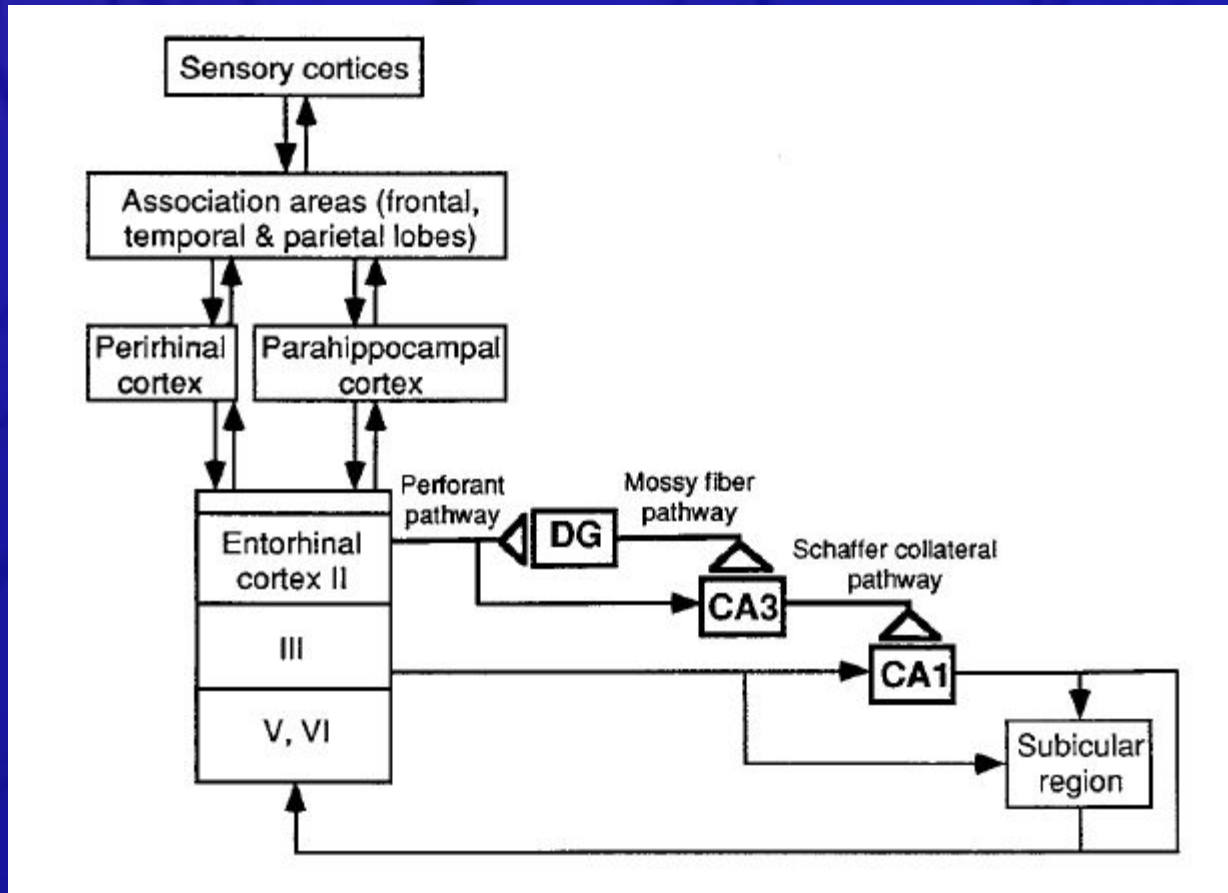

Chen & Tonegawa, 1997

a Encoding and tagging

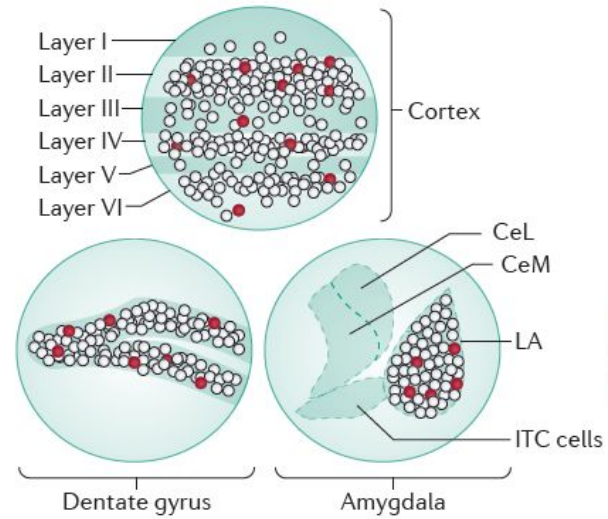

b Storage

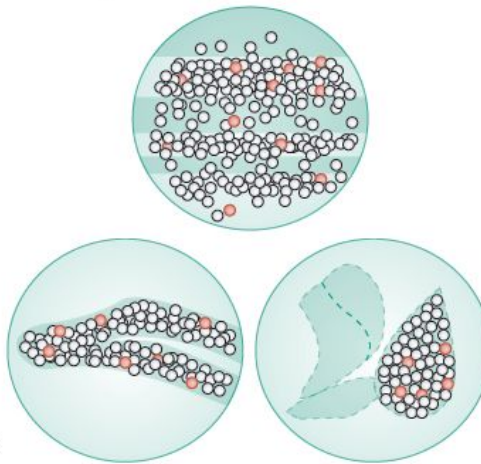

c Retrieval

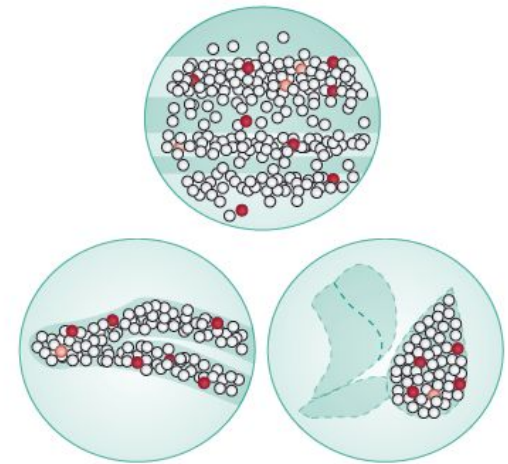

Context 1

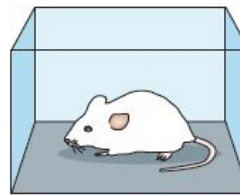

Home cage



Context 1

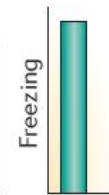

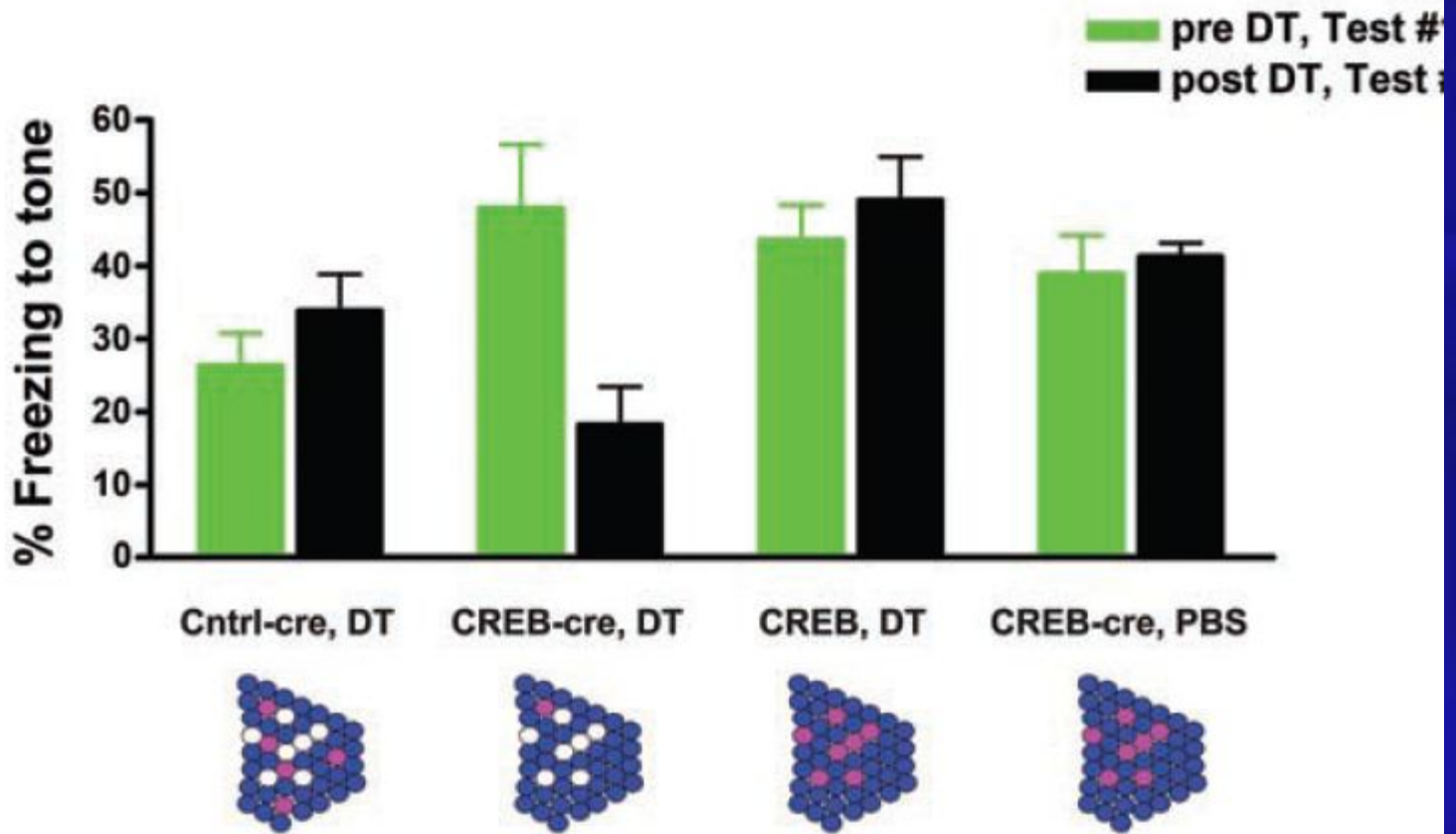

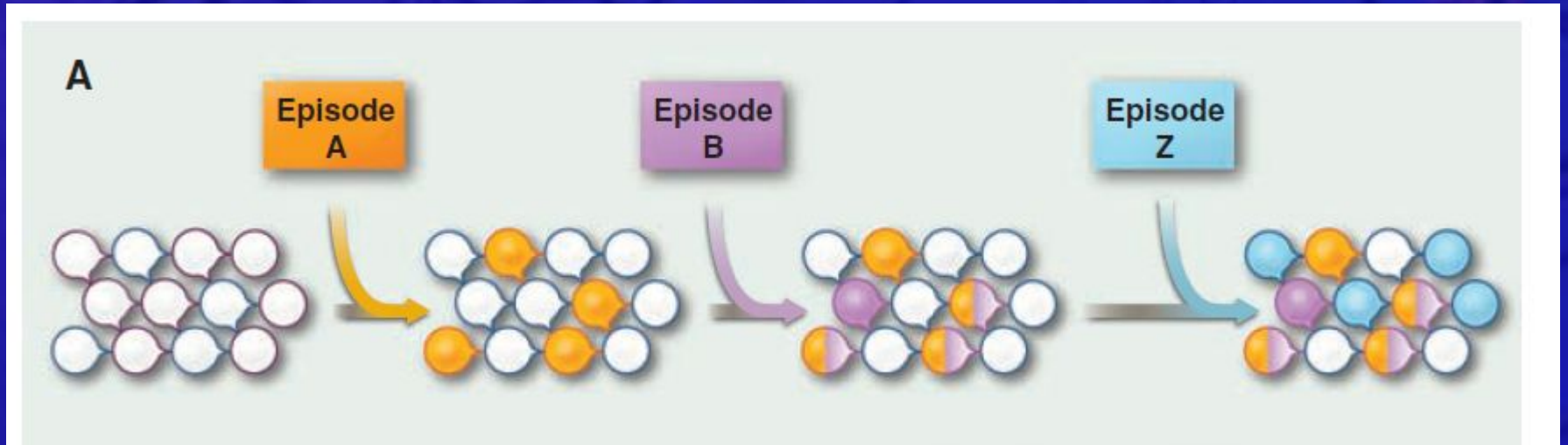

Silva et al., 2009

B

Event 1



Event 2

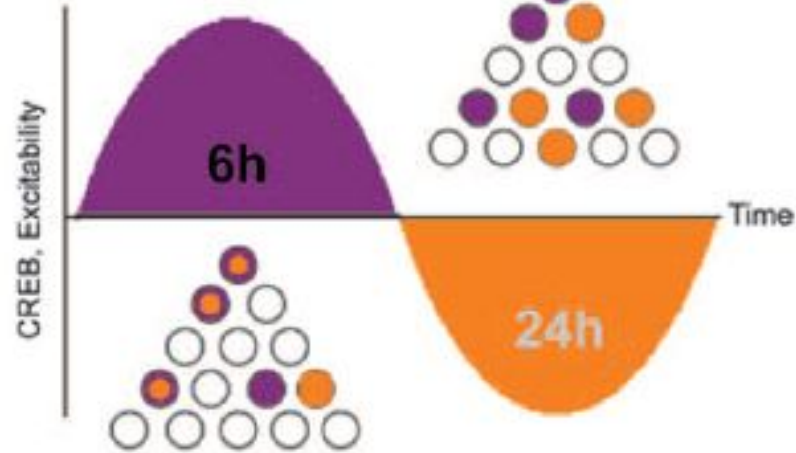

memory enhancement,
co-allocation,
memories linked

no memory enhancement,
dis-allocation,
memories separated

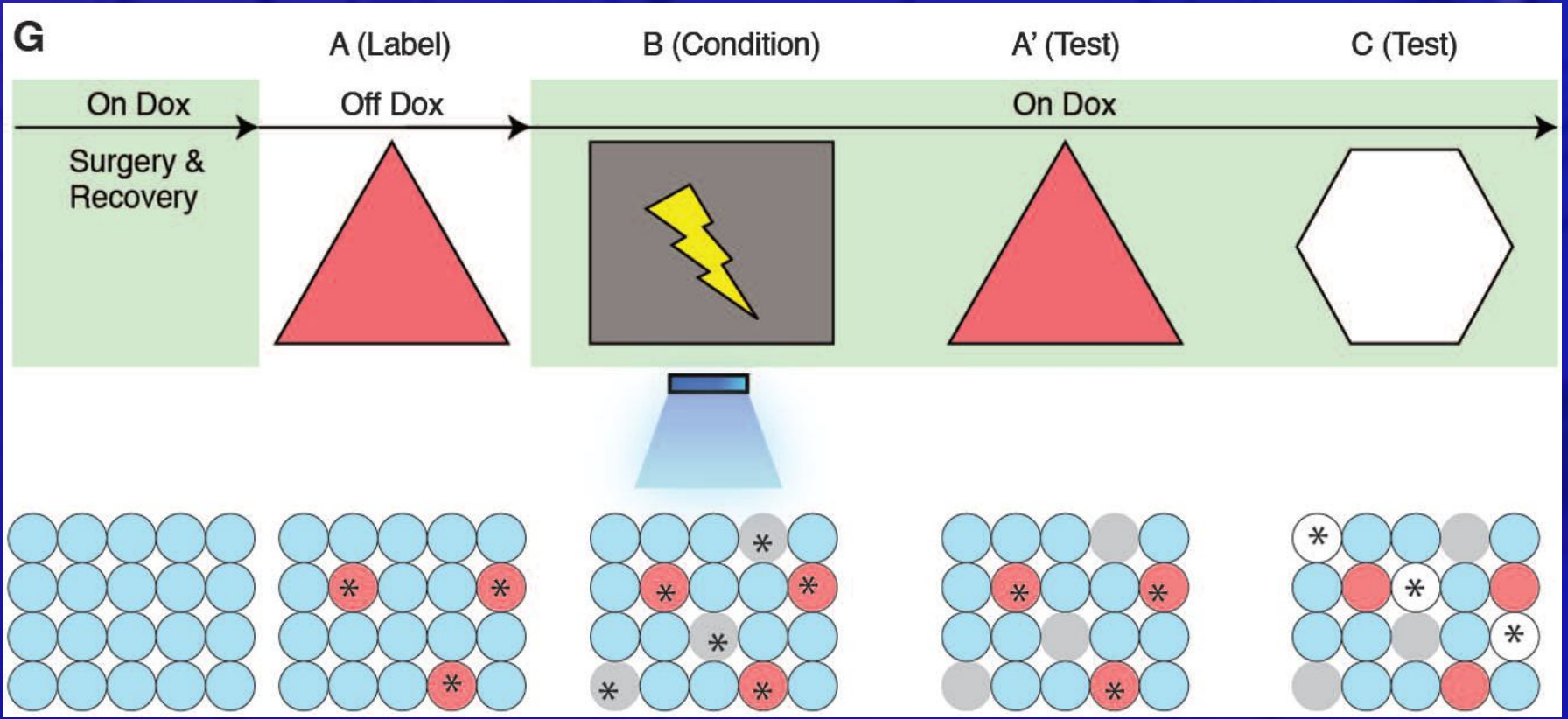

Ramirez et al., 2013



Лирическое
отступление №2

Насколько феномены психического отделимы друг от друга?

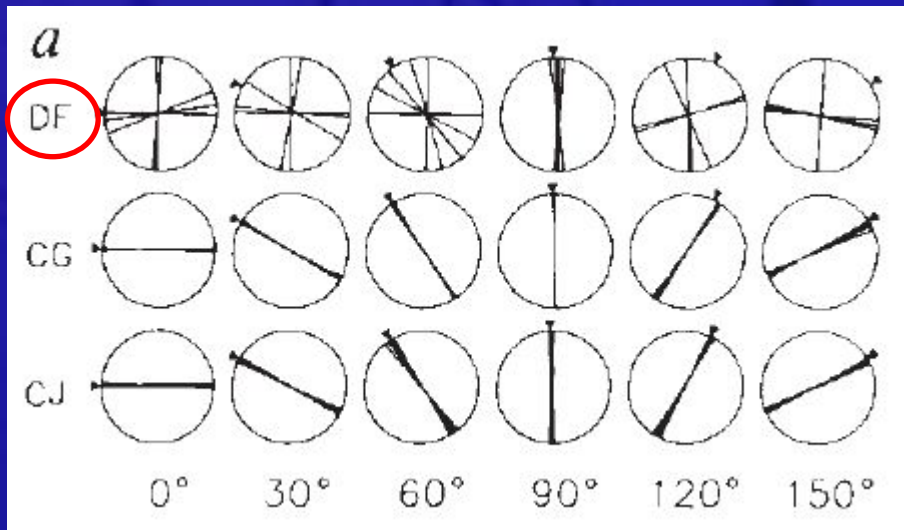

«ориентируйте карту как щель на диске»

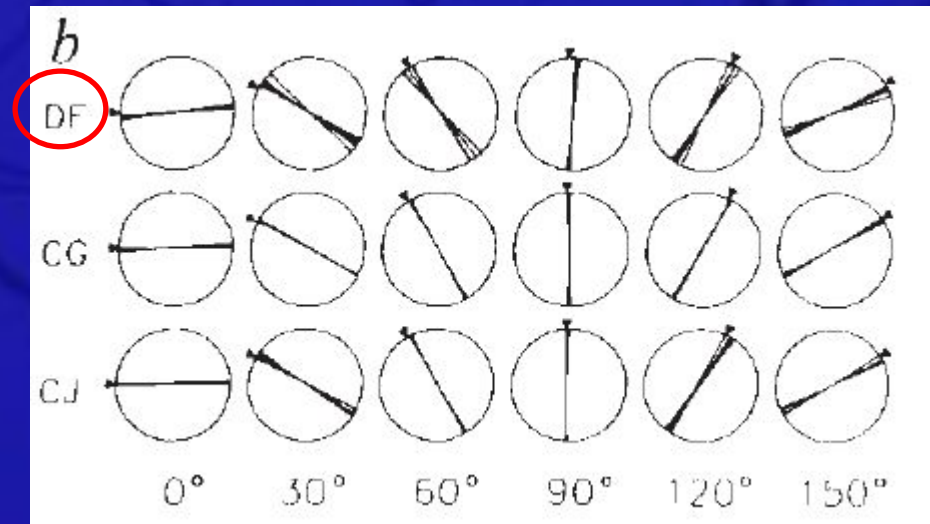

«опустите карту в щель»

Goodale et al., 1999

**Восприятие,
понимание,
мышление,
сознание?**

Откуда мы вообще знаем о существовании этих
сущностей?

– Это же ясно, – сказал я. – Одинаковый уровень переработки информации. Реакция на уровне инстинкта.

Он вздохнул.

– Слова, – сказал он. – Правда, вы не сердитесь, но это же только слова. Это же мне не поможет. Мне надо искать следы разума во Вселенной, а я не знаю, что такое разум. А мне говорят о разных уровнях переработки информации.

(А. Стругацкий, Б. Стругацкий. Полдень, XXII век)

Воспроизведение опыта «В БОДОВО»

a

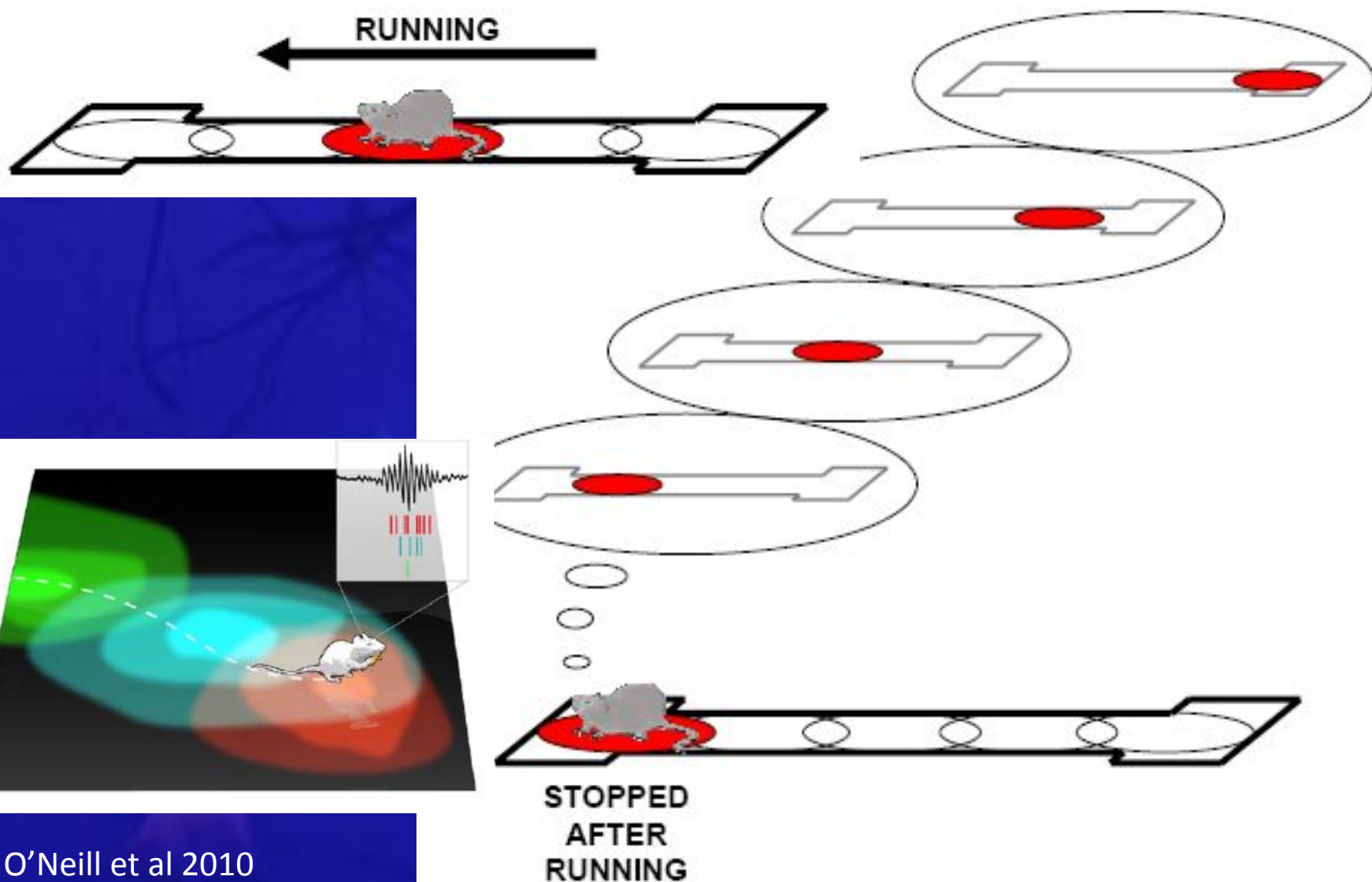

(c)

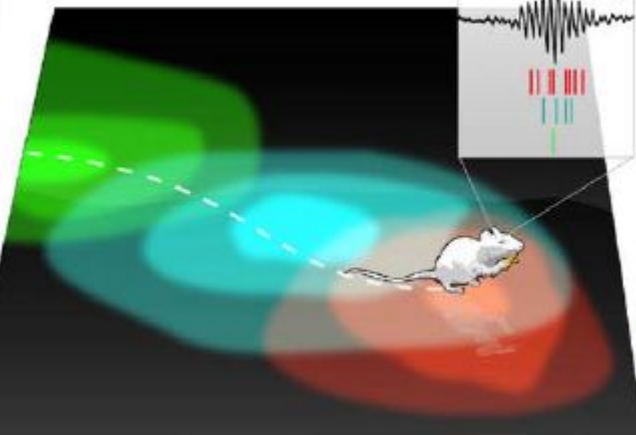

«Продумывание» вариантов при принятии решения

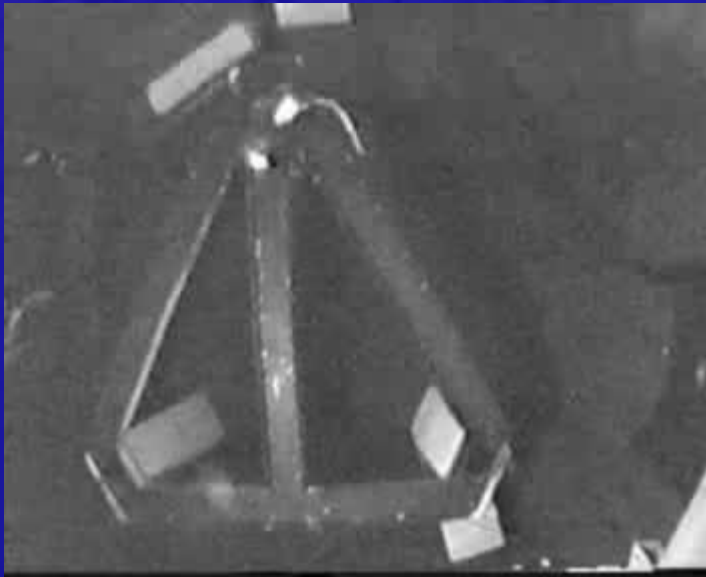

Hippocampal place cells represent spatial episodes (routes)

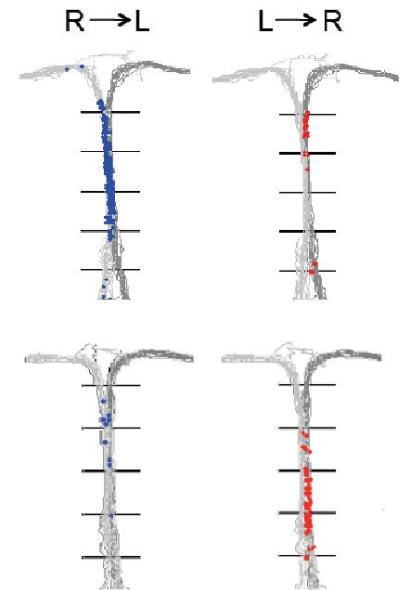
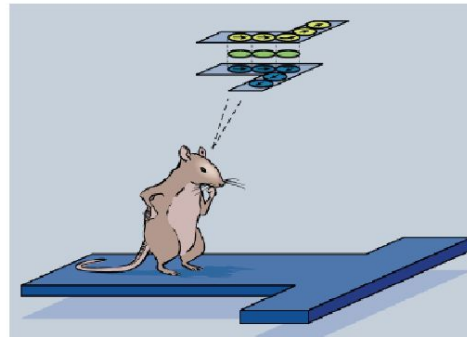
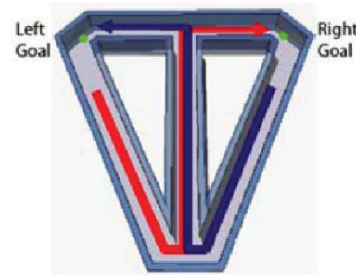

Wood et al., *Neuron* 27:623 2000

«Продумывание» вариантов при принятии решения

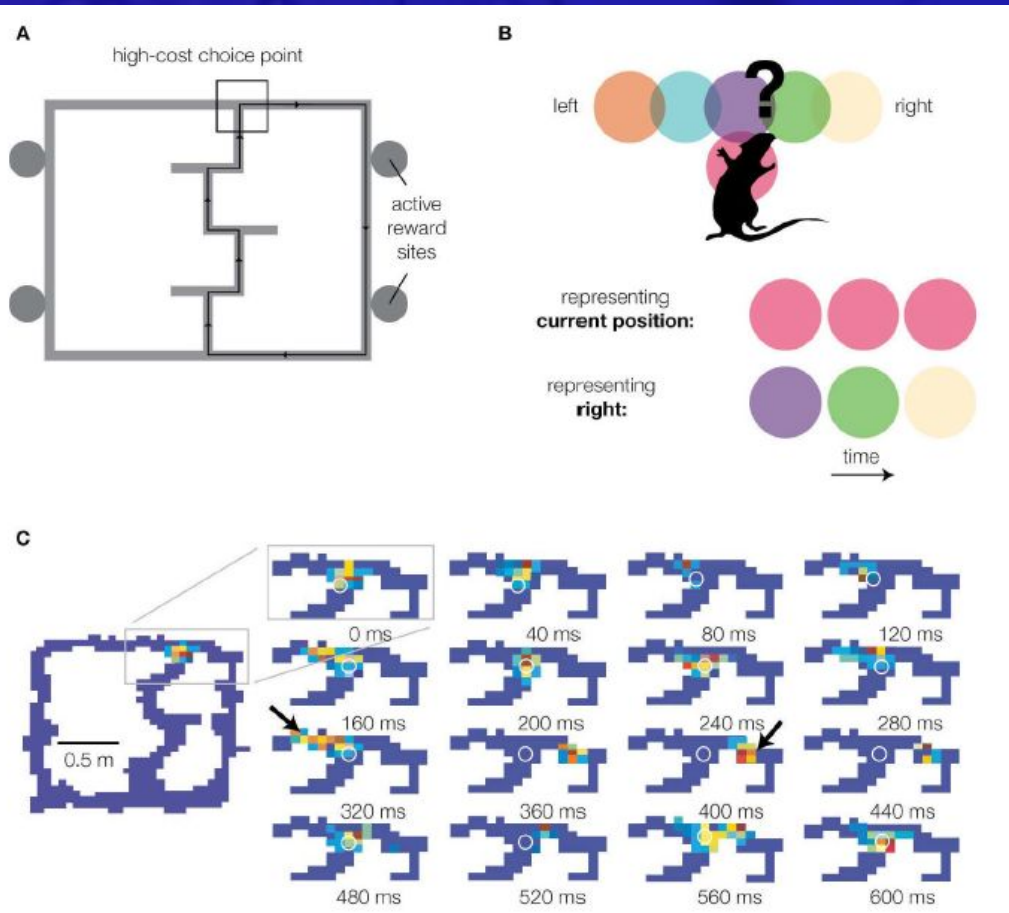
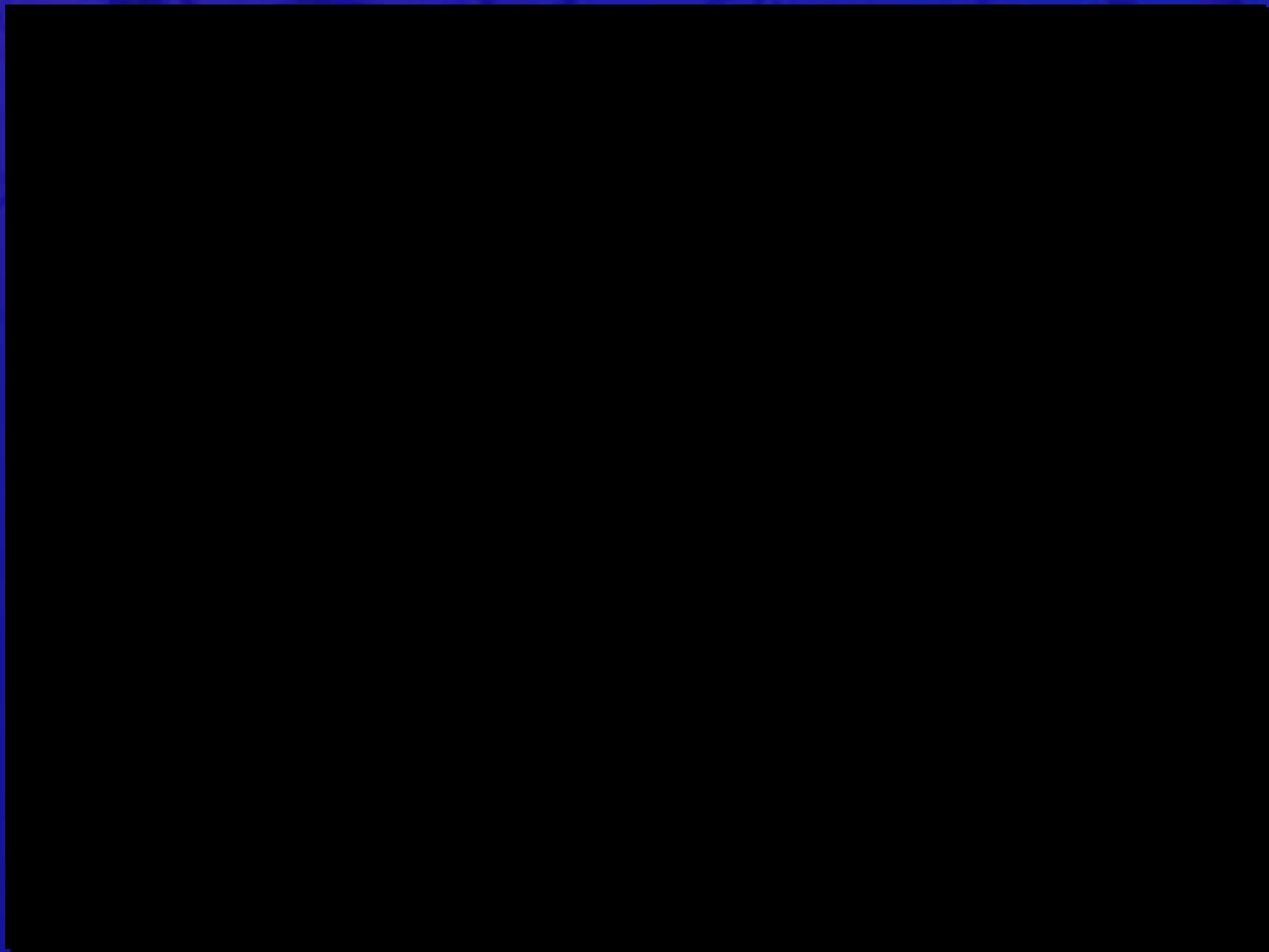
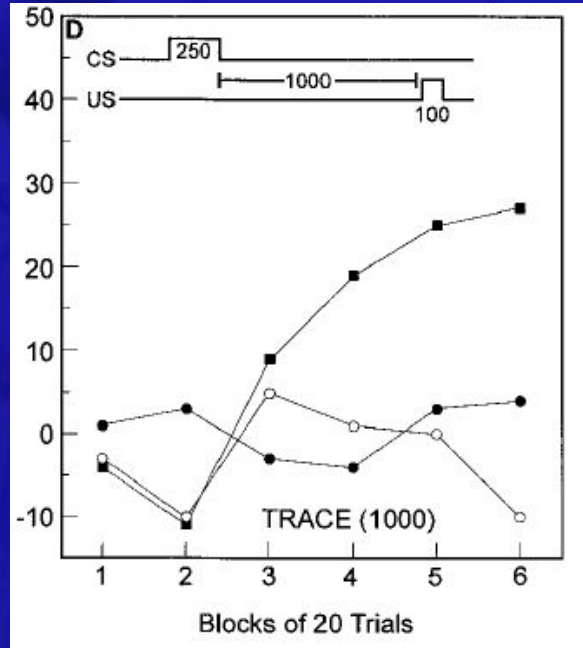
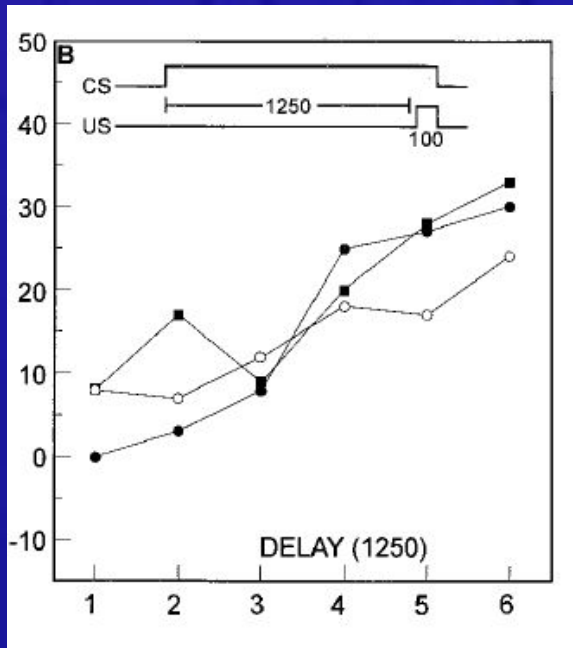

Figure 1 | Representation of forward possibilities at the choice point of the Multiple-T maze. (A) The

which cells are active at any given time, we can infer what location is being represented. If the rat is simply



Поддержание активности нейронов



SEMs ranged from 0.03 to 0.08. (A) ■, aware ($n = 3$); ●, unaware ($n = 9$). (B) ■, aware ($n = 7$); ●, unaware ($n = 3$); ○, AMN ($n = 4$). (C) ■, aware ($n = 5$); ●, unaware ($n = 7$). (D) ■, aware ($n = 7$); ●, unaware ($n = 7$); ○, AMN ($n = 4$).

Clark & Squire,
1998

Корреляты сознания

- Уровень сложности нейронной активности
- Частота активности нейронов («повторный вход»)
- Синхронизация активности нейронов по всему мозгу

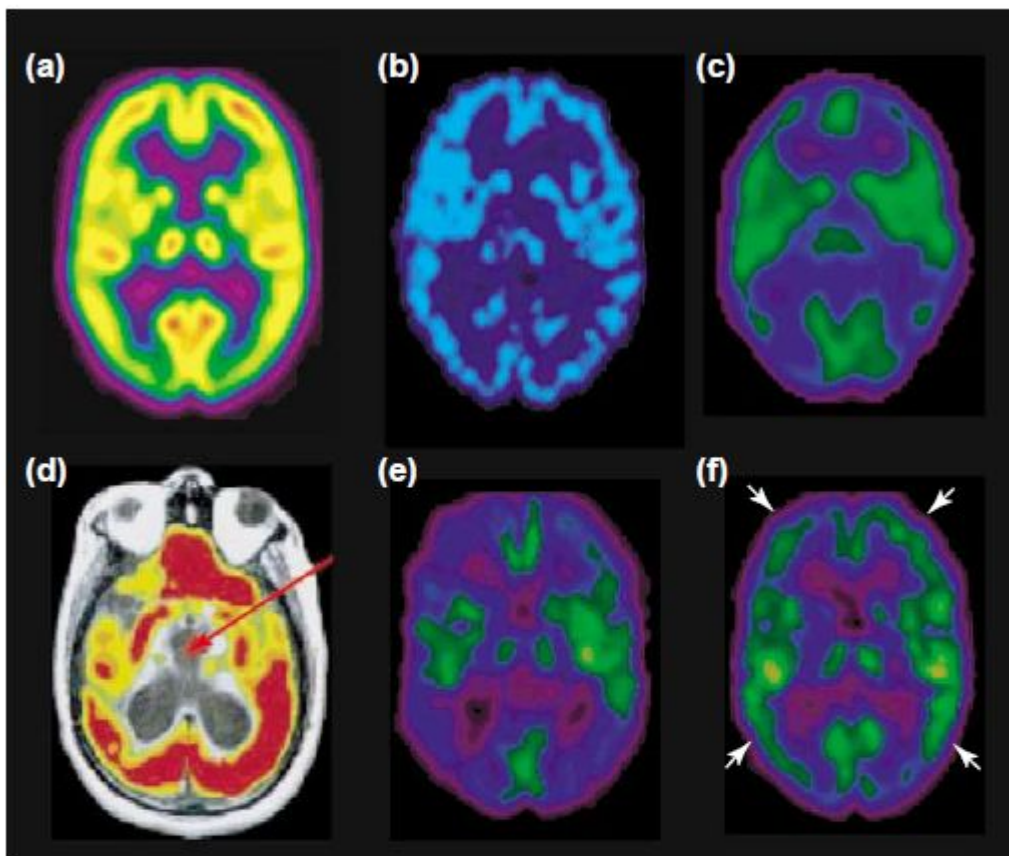

Figure 2. PET images illustrating that overall cerebral metabolic rates for glucose are about twice as high in the 'conscious waking state' (a) (Laureys *et al.*, unpublished), as compared with altered states of wakefulness such as general anesthesia (b) (from [3]), and deep sleep (c) (adapted from [4]). In the vegetative state (i.e. wakeful unawareness) overall global cortical metabolism can sometimes have close-to-normal values (d) (patient 5 from [5] in a vegetative state following herniation and bilateral paramedian mesodiencephalic injury (red arrow). By contrast, vegetative patients who recover might show no substantial increase in global metabolic function: (e) patient scanned in a vegetative state following CO intoxication; (f) same patient, in whom full recovery of awareness was accompanied by restoration of activity solely in frontoparietal areas (white arrows; adapted from [7]).

Review

Neural Correlates of Unconsciousness in Large-Scale Brain Networks

George A. Mashour^{1,*} and Anthony G. Hudetz¹

The biological basis of consciousness is one of the most challenging and fundamental questions in 21st century science. A related pursuit aims to identify the neural correlates and causes of unconsciousness. We review current trends in the investigation of physiological, pharmacological, and pathological states of unconsciousness at the level of large-scale functional brain networks. We focus on the roles of brain connectivity, repertoire, graph-theoretical techniques, and neural dynamics in understanding the functional brain disconnections and reduced complexity that appear to characterize these states. Persistent questions in the field, such as distinguishing true correlates, linking neural scales, and understanding differential recovery patterns, are also addressed.

Highlights

fMRI, high-density EEG, MEG, and ECoG are used to assess brain networks during unconsciousness.

Large functional brain networks reconstructed from neuroimaging and neurophysiologic data are analyzed with various connectivity measures, graph theory, and methods that reveal dynamics.

Sleep, general anesthesia, and disorders of consciousness are characterized by disrupted functional

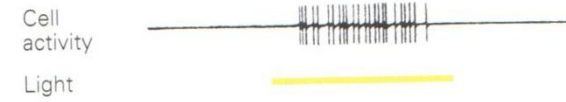
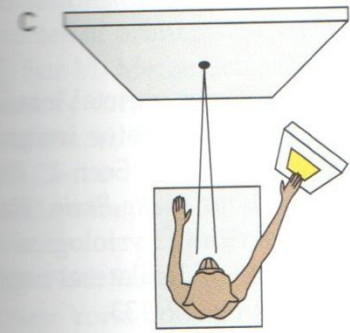
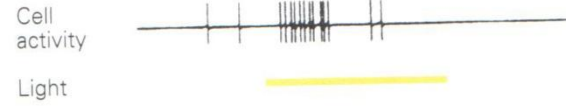
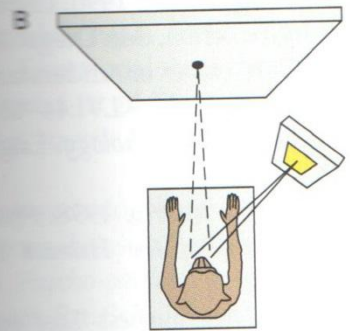
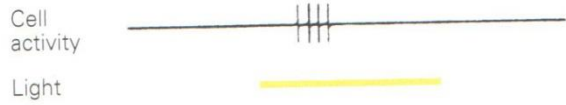
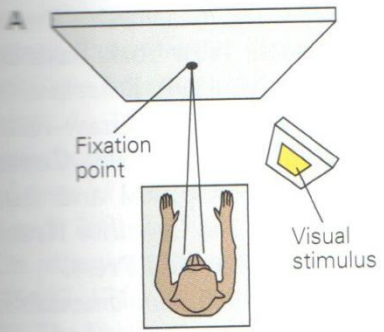

200 ms

Internally generated preactivation of single neurons in the human brain predicts volition

Fried I., Mukamel R., Kreiman G.

Single neuron in left pre-SMA during three consecutive trials

Fried et al, 2011

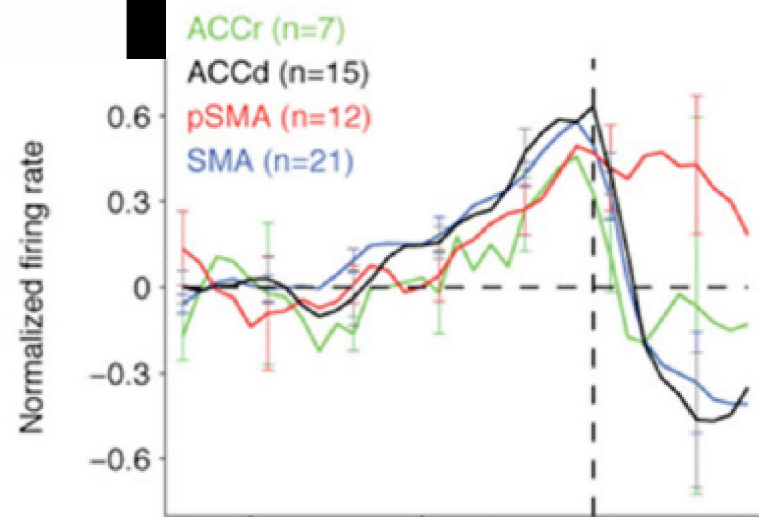

**Состояния «сознательные» -
определенная организация нейронной
активности во времени и пространстве**

